

# MOLO



MOLTO LUCE®



# **MOLTO LUCE & EGOLUCE**

## **eine leuchtende Harmonie**

In einer Ära, die von unaufhaltsamem Wandel und rasendem Fortschritt geprägt ist, erlangen Beständigkeit und Konstanz eine unschätzbare Bedeutung, denn sie schaffen Vertrauen und Sicherheit und diese Dinge benötigt es, damit wertvolle und inspirierende Partnerschaften entstehen können so wie jene von Molto Luce und EgoLuce.

Seit nunmehr 40 Jahren befinden wir uns auf einer gemeinsamen Reise durch die faszinierende Welt des Lichts und sind von den Anfängen bis Heute stetig zusammen gewachsen. Die Grundpfeiler, auf die sich diese erfolgreiche Partnerschaft stützt, umfassen nicht nur den Anspruch an höchste Qualität, sondern auch die gemeinsame Leidenschaft für Design und Ästhetik und dies immer angepasst an die höchsten Standards der Technologie.

Molto Luce und EgoLuce haben nicht nur erfolgreich gemeinsam die Herausforderungen der Zeit gemeistert, sondern setzen auch zukünftig weiterhin miteinander Maßstäbe in der Lichtbranche.

# OBERFLÄCHEN



**.01** Weiß



**.02** Schwarz



**.05** Rot



**.06** Grün



**.09** Orange



**.10** Hellblau



**.11** Rosa



**.14** Schultafel

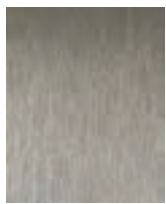

**.23** Aluminium  
Satiniert



**.24** Black Chrom



**.25** Gold  
Satiniert



**.29** Blattgold



**.30** Blattsilber



**.31** Verchromt

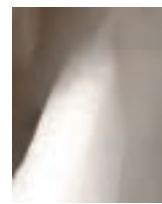

**.32** Nickel matt



**.33** Edelstahl  
AISI 316L



**.34** Lackiert  
Corten



**.35** Lackiert  
Sand



**.56** Spiegel



**.57** Weißes Glas



**.70** Retrò



**.71** Fumè

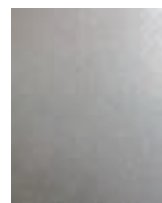

**.85** Lackiert  
Silber



**.86** Lackiert  
Gold



**.87** Lackiert  
Kupfer



**.88** Lackiert  
Bronze



# LAYOUT

Name	Produkt Code	Technische Zeichnungen	Typologie Zeichen																																						
FARO		<p><b>2525</b></p> <table border="1"> <tr> <td>.01</td> <td>White</td> <td>1000lm</td> </tr> <tr> <td>.02</td> <td>Black</td> <td>1000lm</td> </tr> <tr> <td>/W</td> <td>400K LED 5,9W</td> <td>1000lm</td> </tr> <tr> <td>/WW</td> <td>3000K LED 5,9W</td> <td>1000lm</td> </tr> <tr> <td>/XW</td> <td>2700K LED 5,9W</td> <td>1000lm</td> </tr> </table> <p><b>3536</b></p> <table border="1"> <tr> <td>.01</td> <td>White</td> <td>3120lm</td> </tr> <tr> <td>.02</td> <td>Black</td> <td>3120lm</td> </tr> <tr> <td>/W</td> <td>400K LED 11,8W</td> <td>3120lm</td> </tr> <tr> <td>/WW</td> <td>3000K LED 11,8W</td> <td>3120lm</td> </tr> <tr> <td>/XW</td> <td>2700K LED 11,8W</td> <td>3120lm</td> </tr> </table> <p><b>ACCESSORIES</b></p> <p><b>0267/S</b></p> <table border="1"> <tr> <td>.01</td> <td>White</td> </tr> <tr> <td>.01</td> <td>Black</td> </tr> </table> <p><b>FINISHES CODES</b></p> <table border="1"> <tr> <td>.01</td> <td>White</td> </tr> <tr> <td>.02</td> <td>Black</td> </tr> </table>	.01	White	1000lm	.02	Black	1000lm	/W	400K LED 5,9W	1000lm	/WW	3000K LED 5,9W	1000lm	/XW	2700K LED 5,9W	1000lm	.01	White	3120lm	.02	Black	3120lm	/W	400K LED 11,8W	3120lm	/WW	3000K LED 11,8W	3120lm	/XW	2700K LED 11,8W	3120lm	.01	White	.01	Black	.01	White	.02	Black	
.01	White	1000lm																																							
.02	Black	1000lm																																							
/W	400K LED 5,9W	1000lm																																							
/WW	3000K LED 5,9W	1000lm																																							
/XW	2700K LED 5,9W	1000lm																																							
.01	White	3120lm																																							
.02	Black	3120lm																																							
/W	400K LED 11,8W	3120lm																																							
/WW	3000K LED 11,8W	3120lm																																							
/XW	2700K LED 11,8W	3120lm																																							
.01	White																																								
.01	Black																																								
.01	White																																								
.02	Black																																								
	Technische Daten	Technische Symbole	Stillleben Bild																																						

## PRODUKTANGABEN



Fettgedruckte Zeichen werden für Codes und Spezifikationen verwendet, die zur Identifizierung des in der Bestellung anzugebenden Produktcodes nötig sind.

Farbcode-Endung	<b>2525</b> / <b>3536</b>	Lumen Pakete															
Lichtfarbe	<table border="1"> <tr> <td>.01</td> <td>White</td> <td>1000lm</td> </tr> <tr> <td>.02</td> <td>Black</td> <td>1000lm</td> </tr> <tr> <td>/W</td> <td>400K LED 5,9W</td> <td>1000lm</td> </tr> <tr> <td>/WW</td> <td>3000K LED 5,9W</td> <td>1000lm</td> </tr> <tr> <td>/XW</td> <td>2700K LED 5,9W</td> <td>1000lm</td> </tr> </table>	.01	White	1000lm	.02	Black	1000lm	/W	400K LED 5,9W	1000lm	/WW	3000K LED 5,9W	1000lm	/XW	2700K LED 5,9W	1000lm	
.01	White	1000lm															
.02	Black	1000lm															
/W	400K LED 5,9W	1000lm															
/WW	3000K LED 5,9W	1000lm															
/XW	2700K LED 5,9W	1000lm															

## SYMBOLE

-  Aufhängung - Decke
-  Wand
-  Boden - Tisch
-  Inklusive Konverter
-  Konverter nicht enthalten
-  Kabellänge
-  Inklusive Dimmer
-  CRI
-  Halterung Wiederverwendbar
-  Drehbarkeit
-  Ausstrahlwinkel
- IP65 Schutzart I = Staub/ P = Wasser

## MARKIERUNGEN

-  Schutzklasse II, mit doppelter verstärkter Isolierung
-  Schutzklasse III - SELV mit externem Konverter
-  Halterung für die Installation auf normal entflammaren Oberflächen

## ZUBEHÖR CODES

-  **/DIM** Dimmen
-  **/DIM** Dimmen
-  **/DALI** Dimmen

## LICHTFARBCODES

- /W** Natürlich Weiß Led 4000K
- /WW** Warmweiß Led 3000K
- /XW** Extra weiße Led 2700K

- /EM** Notfall
- /ST** Satinierter Diffusor
- /TR** Transparenter Diffusor

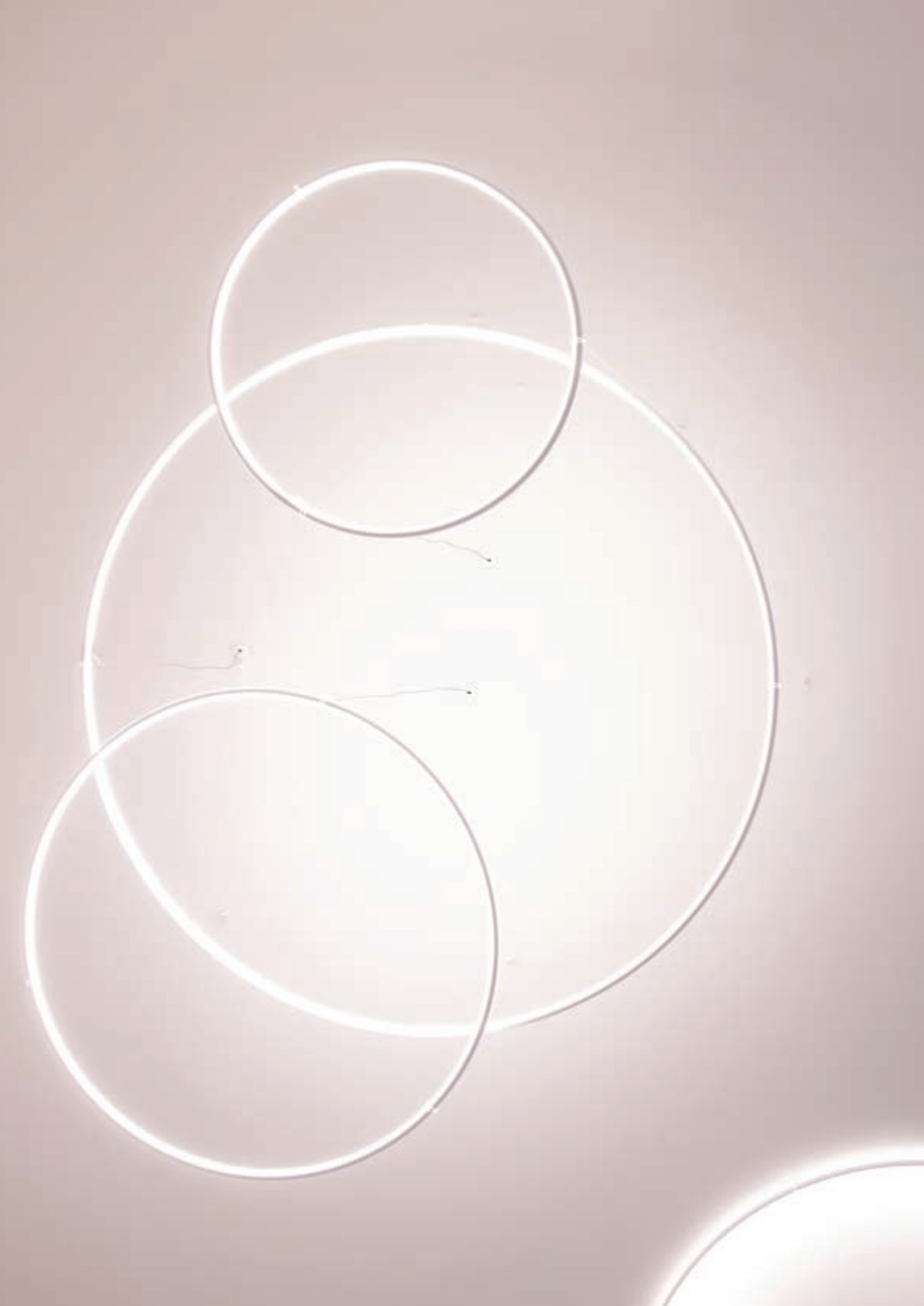





INDOOR

# LANCIA

Design P. Peperè





Pendelleuchte mit diffusem Licht.

Der Körper besteht aus einem kalandrierten Aluminiumprofil, einem opalen Polycarbonat-Diffusor und einem koaxialen Stromkabel. Erhältlich in verschiedenen Größen und verschiedenen Ausführungen.

Die Besonderheit des nach innen gerichteten Lichtstroms garantiert einen besonders hohen Sehkomfort und trägt zur Leichtigkeit der Konstruktion bei.



# LANCIA TONDA

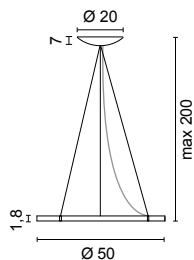

**1566.**\_\_/\_/\_\_\_ 0,75 Kg

<b>.01</b>	White	
<b>.02</b>	Black	
<b>.25</b>	Golden satin	
<b>.31</b>	Chromed	
<b>.85</b>	Painted silver finishing	
<b>.86</b>	Painted gold finishing	
<b>.87</b>	Painted copper finishing	
<b>.88</b>	Painted bronze finishing	

<b>/W</b>	4000K	LED 27W	CRI>90	3390lm
<b>/WW</b>	3000K	LED 27W	CRI>90	3030lm
<b>/XW</b>	2700K	LED 27W	CRI>90	2835lm



Dimmbar auf Anfrage

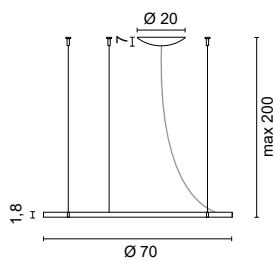

**1562.**\_\_/\_/\_\_\_ 1,10 Kg

<b>.01</b>	White	
<b>.02</b>	Black	
<b>.25</b>	Golden satin	
<b>.31</b>	Chromed	
<b>.85</b>	Painted silver finishing	
<b>.86</b>	Painted gold finishing	
<b>.87</b>	Painted copper finishing	
<b>.88</b>	Painted bronze finishing	

<b>/W</b>	4000K	LED 37,8W	CRI>90	4746lm
<b>/WW</b>	3000K	LED 37,8W	CRI>90	4242lm
<b>/XW</b>	2700K	LED 37,8W	CRI>90	3969lm



Dimmbar auf Anfrage

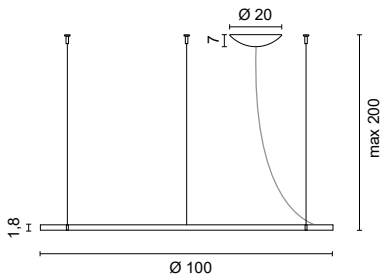

**1563.**\_\_/\_/\_\_\_ 1,45 Kg

<b>.01</b>	White	
<b>.02</b>	Black	
<b>.85</b>	Painted silver finishing	
<b>.86</b>	Painted gold finishing	
<b>.87</b>	Painted copper finishing	
<b>.88</b>	Painted bronze finishing	

<b>/W</b>	4000K	LED 54W	CRI>90	6780lm
<b>/WW</b>	3000K	LED 54W	CRI>90	6060lm
<b>/XW</b>	2700K	LED 54W	CRI>90	5670lm



Dimmbar auf Anfrage

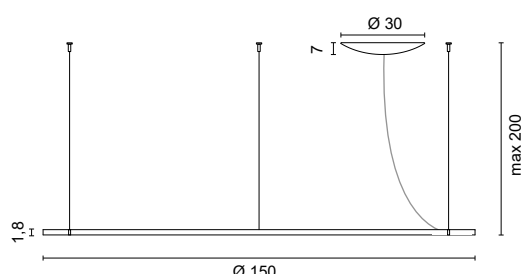

**1564.**\_\_/\_/\_\_\_ 2,35 Kg

<b>.01</b>	White	
<b>.02</b>	Black	
<b>.85</b>	Painted silver finishing	
<b>.86</b>	Painted gold finishing	
<b>.87</b>	Painted copper finishing	
<b>.88</b>	Painted bronze finishing	

<b>/W</b>	4000K	LED 81W	CRI>90	10170lm
<b>/WW</b>	3000K	LED 81W	CRI>90	9090lm
<b>/XW</b>	2700K	LED 81W	CRI>90	8505lm



Dimmbar auf Anfrage

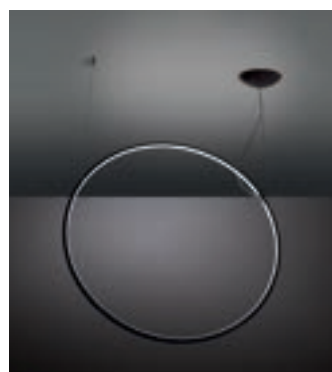
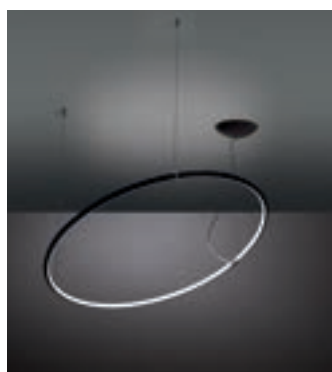
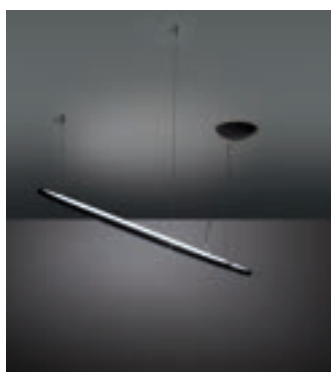
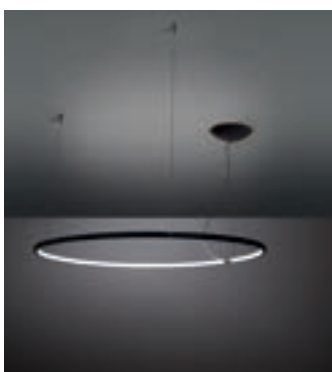







## ZUBEHÖR

Komponente Abhängung  
 Ø 1,7cm H 5cm

**0536.\_ \_**

<b>.01</b>	White	
<b>.02</b>	Black	
<b>.25</b>	Golden satin	
<b>.31</b>	Chromed	



## AUSFÜHRUNGEN CODE



**.01** Weiß

**.02** Schwarz

**.25** Gold satiniert

**.31** Verchromt

**.85** Lackiert  
Silber

**.86** Lackiert  
Gold

**.87** Lackiert  
Kupfer

**.88** Lackiert  
Bronze





*SomVita Suites  
Ph. Hannes Niederkofler*







LANCIA TONDA XL - XXL - MEGA





# LANCIA TONDA XL - XXL - MEGA

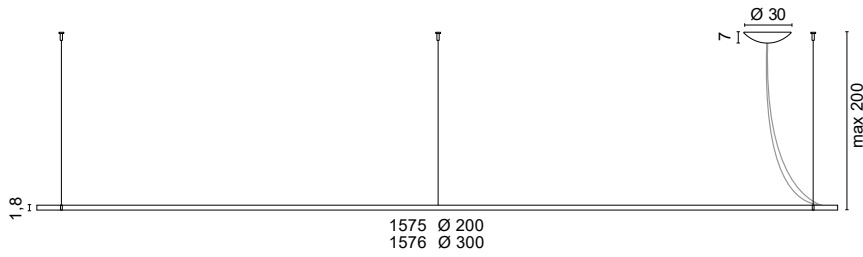

**1575.**\_\_/\_/\_\_\_ 3,00 Kg

- .01 White
- .02 Black

/W	4000K	LED 67W	CRI>90	7560lm
/WW	3000K	LED 67W	CRI>90	7140lm
/XW	2700K	LED 67W	CRI>90	6720lm



**1576.**\_\_/\_/\_\_\_ 5,00 Kg

- .01 White
- .02 Black

/W	4000K	LED 96W	CRI>90	10800lm
/WW	3000K	LED 96W	CRI>90	10120lm
/XW	2700K	LED 96W	CRI>90	9600lm

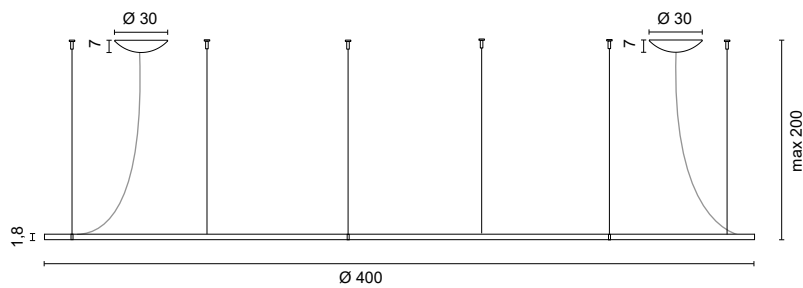

**1578.**\_\_/\_/\_\_\_ 6,00 Kg

- .01 White
- .02 Black

/W	4000K	LED 134W	CRI>90	15120lm
/WW	3000K	LED 134W	CRI>90	14280lm
/XW	2700K	LED 134W	CRI>90	13440lm



## AUSFÜHRUNGEN CODE

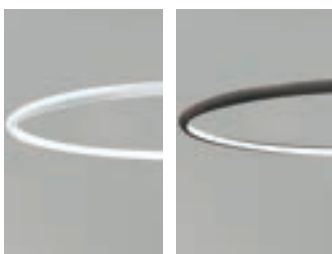

.01 Weiß

.02 Schwarz







**LANCIA TONDA SYSTEM**







# LANCIA TONDA SYSTEM



## KOMPOSITIONEN MIT MEHRFACHABHÄNGUNGEN

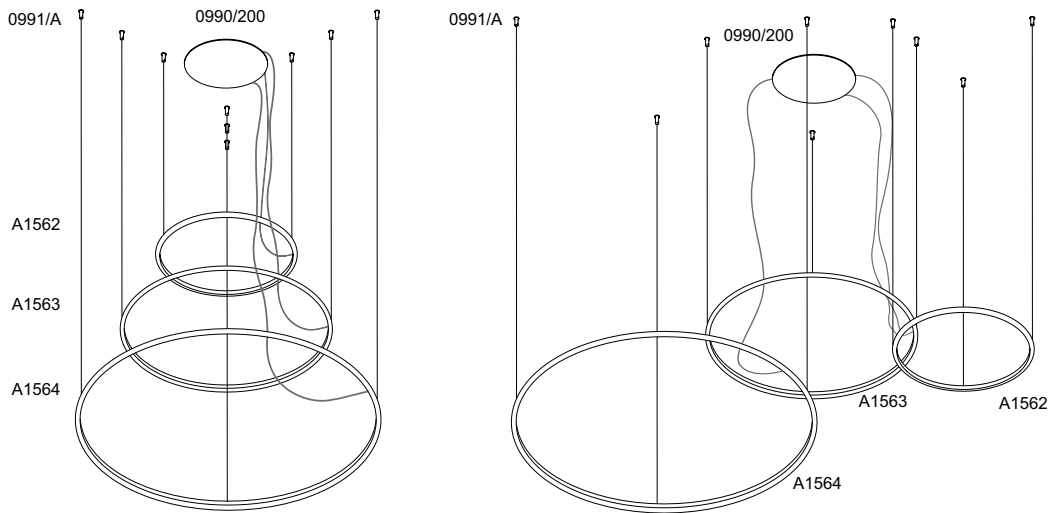

Kabelsatz für eine Lampe

### 0991/A

- 3 Stellkabel 2 mt.
- 3 Element für Kabelbefestigung.
- 3 Aufhängebügel.

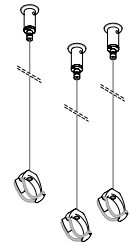

## KOMPOSITIONEN MIT EINZELABHÄNGUNGEN (MAX. 3 LAMPEN)

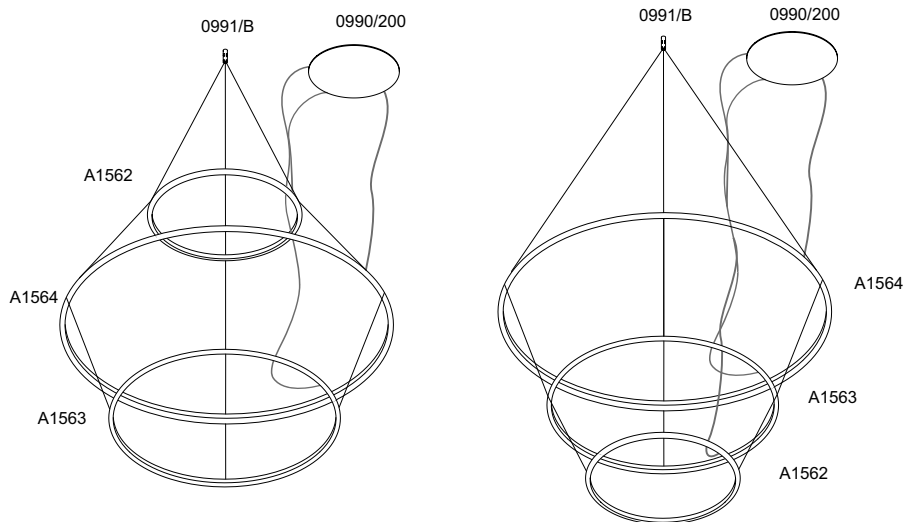

Kabelsatz für 3 Lampen

### 0991/B

- 3 Stellkabel 4 mt.
- 1 Verbindungselement für Kabelbefestigung.
- 3 Aufhängebügel.

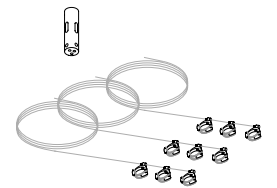

## AUSFÜHRUNGS CODE



.01 Weiß

.02 Schwarz

.25 Gold satiniert

.31 Verchromt

.85 Lackiert  
Silber

.86 Lackiert  
Gold

.87 Lackiert  
Kupfer

.88 Lackiert  
Bronze

## BEISPIELE FÜR KOMPOSITIONEN

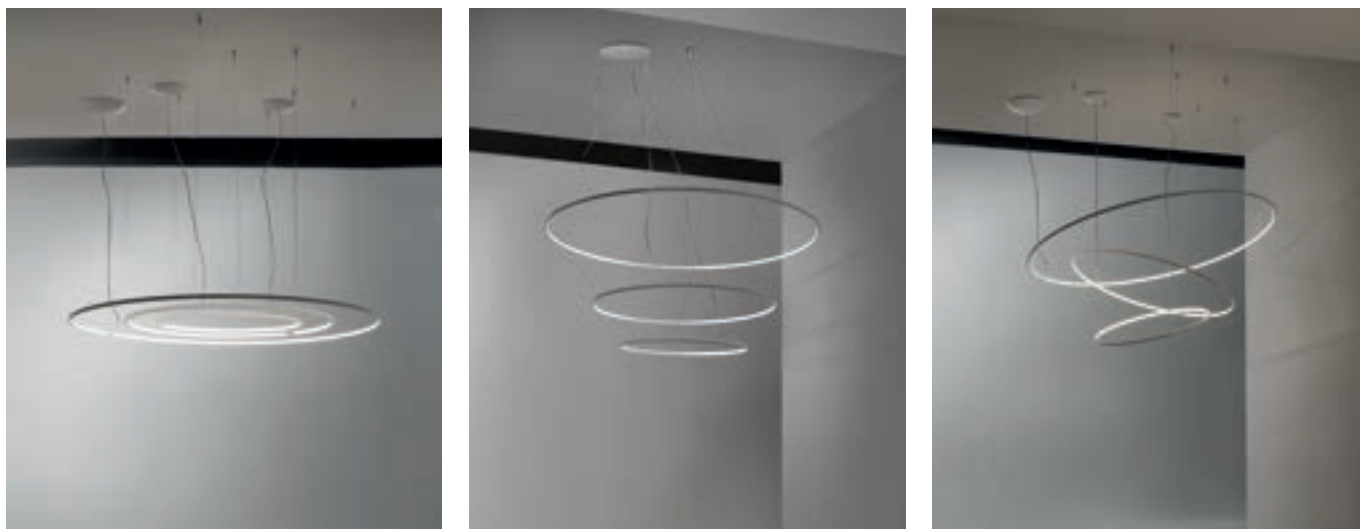

## KUNDENSPEZIFISCHE GRÖSSEN

Tabelle der verfügbaren Längen auf Anfrage.

code	Ø cm	watt	finishes	2700K	lm	3000K	lm	4000K	lm
A1566	50	27	.01 White	/XW	2835	/WW	3030	/W	3390
A1566	50	27	.02 Black	/XW	2835	/WW	3030	/W	3390
A1566	50	27	.25 Golden satin	/XW	2835	/WW	3030	/W	3390
A1566	50	27	.31 Chromed	/XW	2835	/WW	3030	/W	3390
A1566	50	27	.85 Painted silver finishing	/XW	2835	/WW	3030	/W	3390
A1566	50	27	.86 Painted gold finishing	/XW	2835	/WW	3030	/W	3390
A1566	50	27	.87 Painted copper finishing	/XW	2835	/WW	3030	/W	3390
A1566	50	27	.88 Painted bronze finishing	/XW	2835	/WW	3030	/W	3390
A1562	70	37,8	.01 White	/XW	3969	/WW	4242	/W	4776
A1562	70	37,8	.02 Black	/XW	3969	/WW	4242	/W	4776
A1562	70	37,8	.25 Gilded satin	/XW	3969	/WW	4242	/W	4776
A1562	70	37,8	.31 Chromed	/XW	3969	/WW	4242	/W	4776
A1562	70	37,8	.85 Painted silver finishing	/XW	3969	/WW	4242	/W	4776
A1562	70	37,8	.86 Painted gold finishing	/XW	3969	/WW	4242	/W	4776
A1562	70	37,8	.87 Painted copper finishing	/XW	3969	/WW	4242	/W	4776
A1562	70	37,8	.88 Painted bronze finishing	/XW	3969	/WW	4242	/W	4776
A1563	100	54	.01 White	/XW	5670	/WW	6060	/W	6780
A1563	100	54	.02 Black	/XW	5670	/WW	6060	/W	6780
A1563	100	54	.85 Painted silver finishing	/XW	5670	/WW	6060	/W	6780
A1563	100	54	.86 Painted gold finishing	/XW	5670	/WW	6060	/W	6780
A1563	100	54	.87 Painted copper finishing	/XW	5670	/WW	6060	/W	6780
A1563	100	54	.88 Painted bronze finishing	/XW	5670	/WW	6060	/W	6780
A1564	150	81	.01 White	/XW	8505	/WW	9090	/W	10170
A1564	150	81	.02 Black	/XW	8505	/WW	9090	/W	10170
A1564	150	81	.85 Painted silver finishing	/XW	8505	/WW	9090	/W	10170
A1564	150	81	.86 Painted gold finishing	/XW	8505	/WW	9090	/W	10170
A1564	150	81	.87 Painted copper finishing	/XW	8505	/WW	9090	/W	10170
A1564	150	81	.88 Painted bronze finishing	/XW	8505	/WW	9090	/W	10170





Arch. Stefano Campelli, JRC  
Zighetti Illuminazione - Egoluce

LANCIA TONDA



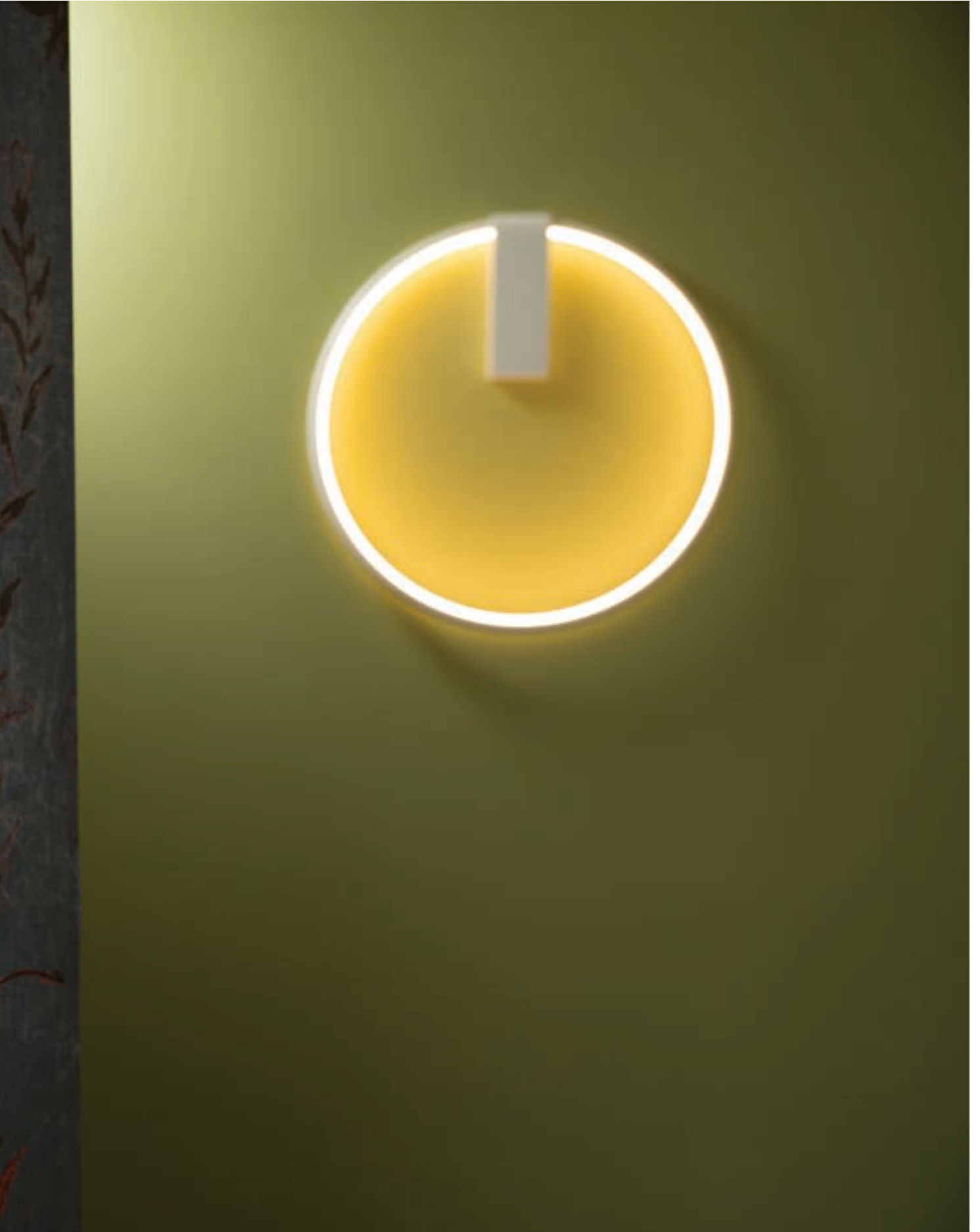

*Arch. Laura Verdi, DEMO HOTEL  
Ph. Flavio Ricci*

# LANCIA TONDA

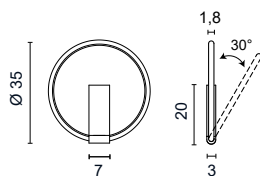

**4605.**\_\_/\_/ \_\_

0,75 Kg

<b>.01</b>	White	
<b>.02</b>	Black	
<b>.25</b>	Golden satin	
<b>.31</b>	Chromed	
<b>.85</b>	Painted silver finishing	
<b>.86</b>	Painted gold finishing	
<b>.87</b>	Painted copper finishing	
<b>.88</b>	Painted bronze finishing	

<b>/W</b>	4000K	LED 18W	CRI>90	2260lm
<b>/WW</b>	3000K	LED 18W	CRI>90	2020lm
<b>/XW</b>	2700K	LED 18W	CRI>90	1 890lm

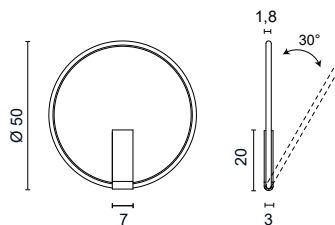

**4606.**\_\_/\_/ \_\_

1,10 Kg

<b>.01</b>	White	
<b>.02</b>	Black	
<b>.25</b>	Golden satin	
<b>.31</b>	Chromed	
<b>.85</b>	Painted silver finishing	
<b>.86</b>	Painted gold finishing	
<b>.87</b>	Painted copper finishing	
<b>.88</b>	Painted bronze finishing	

<b>/W</b>	4000K	LED 27W	CRI>90	3390lm
<b>/WW</b>	3000K	LED 27W	CRI>90	3030lm
<b>/XW</b>	2700K	LED 27W	CRI>90	2835lm



Dimmbar auf Anfrage

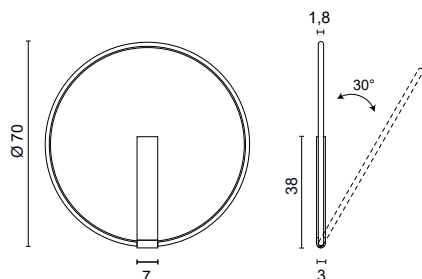

**4607.**\_\_/\_/ \_\_

2,30 Kg

<b>.01</b>	White	
<b>.02</b>	Black	
<b>.25</b>	Golden satin	
<b>.31</b>	Chromed	
<b>.85</b>	Painted silver finishing	
<b>.86</b>	Painted gold finishing	
<b>.87</b>	Painted copper finishing	
<b>.88</b>	Painted bronze finishing	

<b>/W</b>	4000K	LED 36W	CRI>90	4520lm
<b>/WW</b>	3000K	LED 36W	CRI>90	4040lm
<b>/XW</b>	2700K	LED 36W	CRI>90	3780lm



Dimmbar auf Anfrage

## AUSFÜHRUNGEN CODE

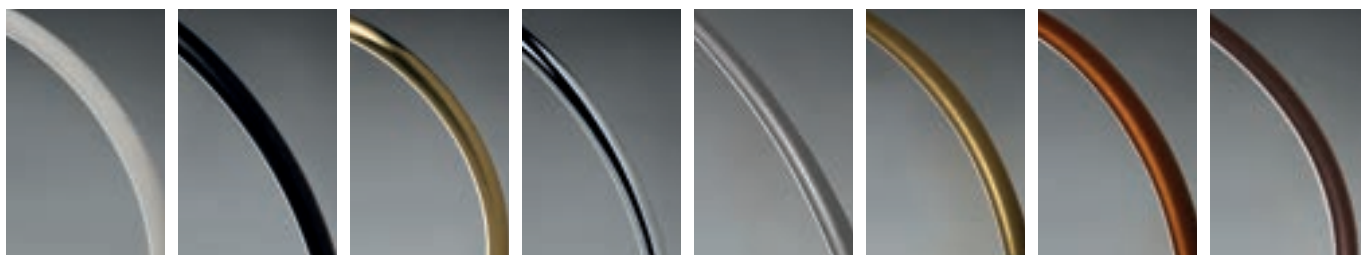

**.01** Weiß

**.02** Schwarz

**.25** Gold satiniert

**.31** Verchromt

**.85** Lackiert  
Silber

**.86** Lackiert  
Gold

**.87** Lackiert  
Kupfer

**.88** Lackiert  
Bronze





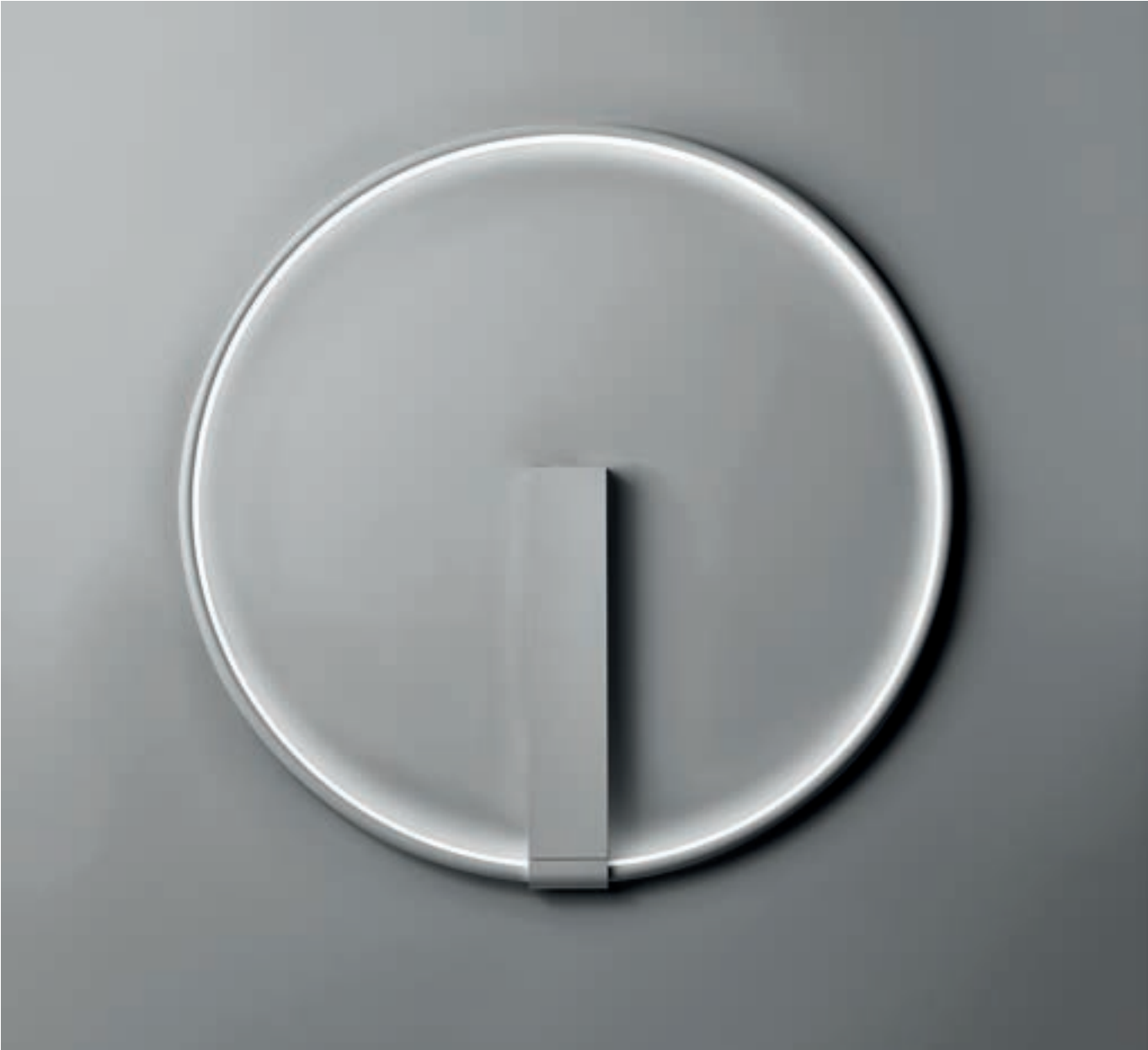







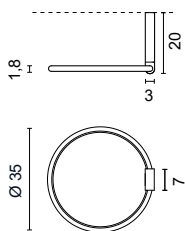

**5602.**\_\_/\_/\_\_\_

0,75 Kg

<b>.01</b>	White	
<b>.02</b>	Black	
<b>.25</b>	Golden satin	
<b>.31</b>	Chromed	
<b>.85</b>	Painted silver finishing	
<b>.86</b>	Painted gold finishing	
<b>.87</b>	Painted copper finishing	
<b>.88</b>	Painted bronze finishing	

<b>/W</b>	4000K	LED 18W	CRI>90	2260lm
<b>/WW</b>	3000K	LED 18W	CRI>90	2020lm
<b>/XW</b>	2700K	LED 18W	CRI>90	1890lm

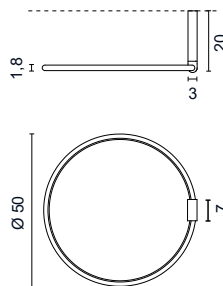

**5603.**\_\_/\_/\_\_\_

1,10 Kg

<b>.01</b>	White	
<b>.02</b>	Black	
<b>.25</b>	Golden satin	
<b>.31</b>	Chromed	
<b>.85</b>	Painted silver finishing	
<b>.86</b>	Painted gold finishing	
<b>.87</b>	Painted copper finishing	
<b>.88</b>	Painted bronze finishing	

<b>/W</b>	4000K	LED 27W	CRI>90	3390lm
<b>/WW</b>	3000K	LED 27W	CRI>90	3030lm
<b>/XW</b>	2700K	LED 27W	CRI>90	2835lm

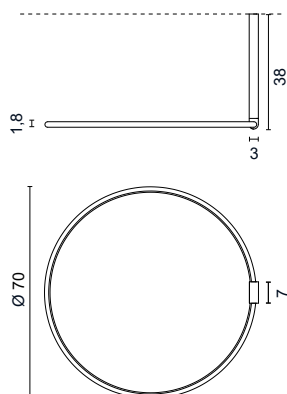

**5604.**\_\_/\_/\_\_\_

2,30 Kg

<b>.01</b>	White	
<b>.02</b>	Black	
<b>.25</b>	Golden satin	
<b>.31</b>	Chromed	
<b>.85</b>	Painted silver finishing	
<b>.86</b>	Painted gold finishing	
<b>.87</b>	Painted copper finishing	
<b>.88</b>	Painted bronze finishing	

<b>/W</b>	4000K	LED 36W	CRI>90	4520lm
<b>/WW</b>	3000K	LED 36W	CRI>90	4040lm
<b>/XW</b>	2700K	LED 36W	CRI>90	3780lm



Dimmbar auf Anfrage

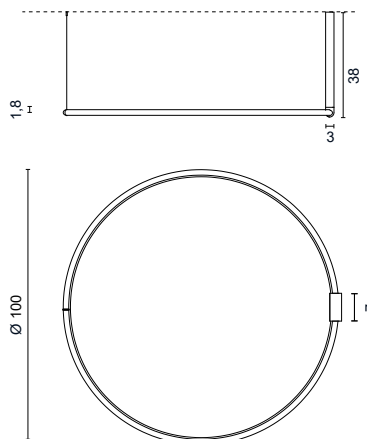

**5605.**\_\_/\_/\_\_\_

3,30 Kg

<b>.01</b>	White	
<b>.02</b>	Black	
<b>.85</b>	Painted silver finishing	
<b>.86</b>	Painted gold finishing	
<b>.87</b>	Painted copper finishing	
<b>.88</b>	Painted bronze finishing	

<b>/W</b>	4000K	LED 54W	CRI>90	6780lm
<b>/WW</b>	3000K	LED 54W	CRI>90	6060lm
<b>/XW</b>	2700K	LED 54W	CRI>90	5670lm



Dimmbar auf Anfrage

## ZUBEHÖR

Platte für gekoppelten Einbau  
Ø 9,5cm 0,20Kg

**0995**

<b>.01</b>	White	
<b>.02</b>	Black	

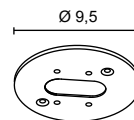

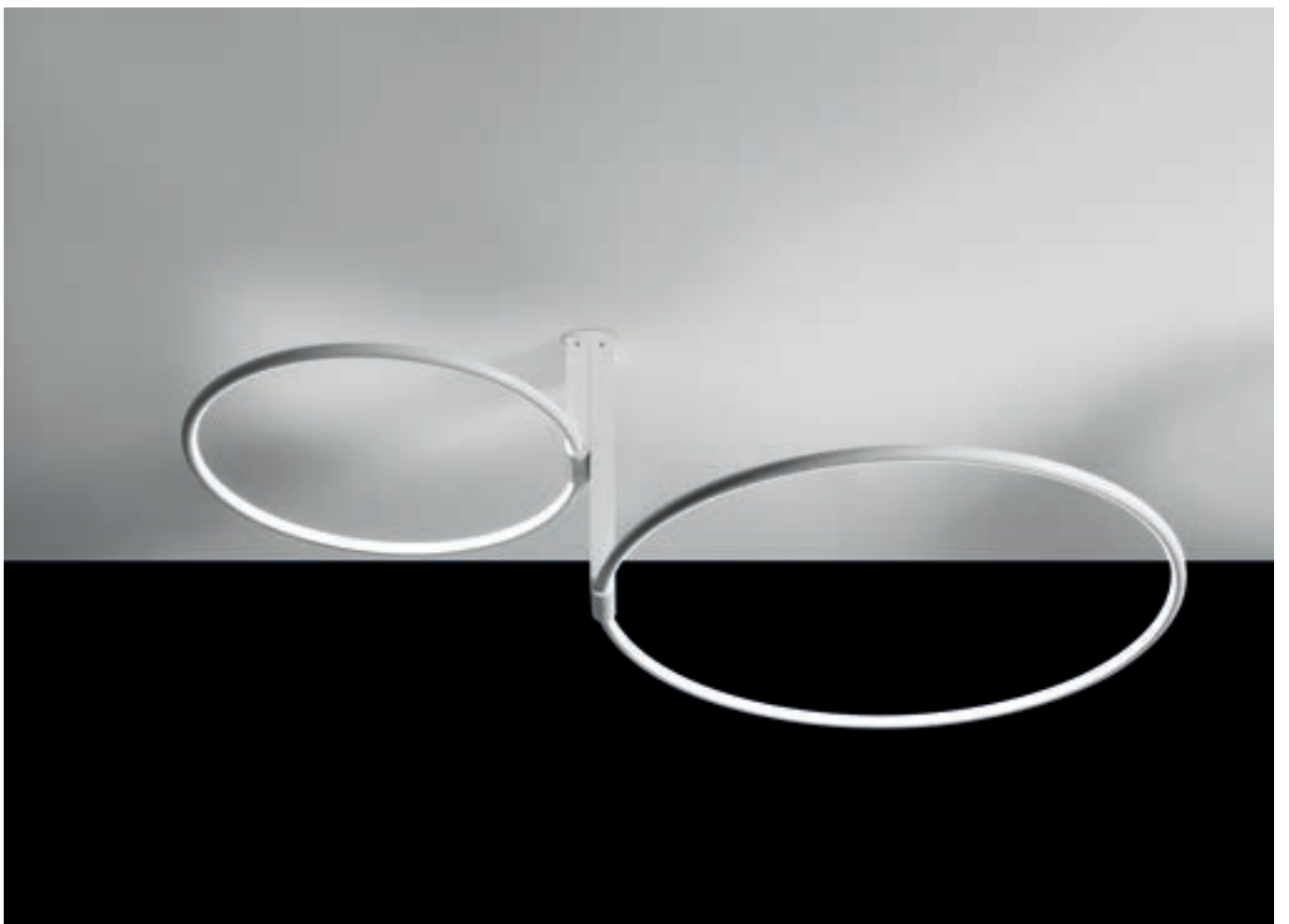

*Beispiel einer Installation mit art.0995.01*



*Deckenhaken für Ø 70/100.*



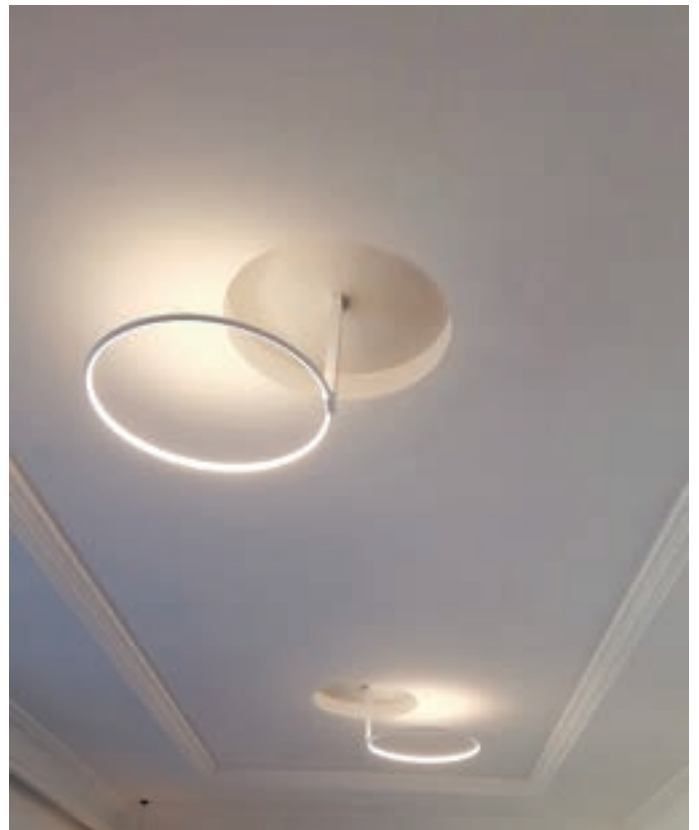

## AUSFÜHRUNGEN CODE

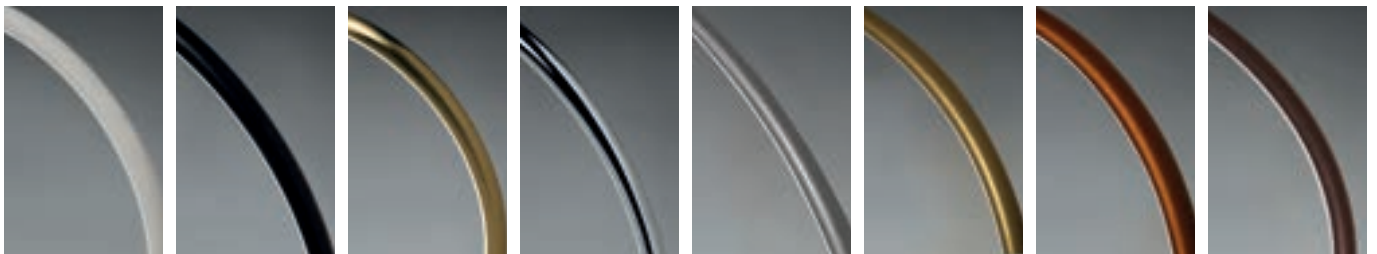

**.01** Weiß

**.02** Schwarz

**.25** Gold satiniert

**.31** Verchromt

**.85** Lackiert  
Silber

**.86** Lackiert  
Gold

**.87** Lackiert  
Kupfer

**.88** Lackiert  
Bronze

**LANCIA TONDA**



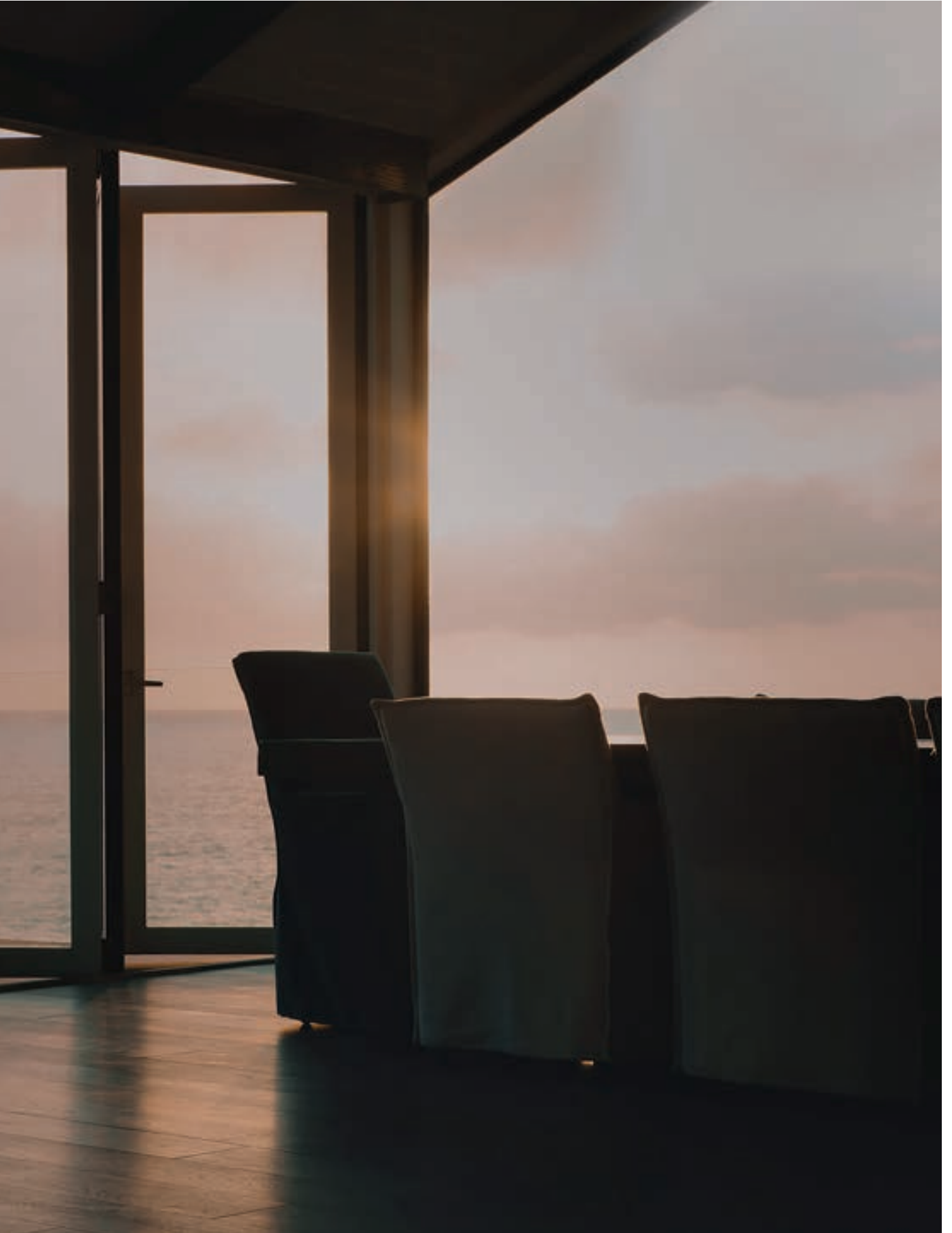





# LANCIA TONDA

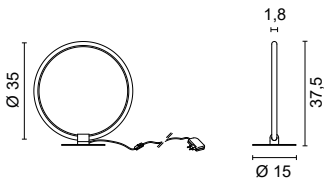

**2513.**\_\_\_/\_\_\_

0,70 Kg

<b>.01</b>	White	
<b>.02</b>	Black	
<b>.25</b>	Golden satin	
<b>.31</b>	Chromed	

<b>/W</b>	4000K	LED 9,6W	CRI>90	1080lm
<b>/WW</b>	3000K	LED 9,6W	CRI>90	1020lm
<b>/XW</b>	2700K	LED 9,6W	CRI>90	960lm



Mit PUSH DIMM am Kabel

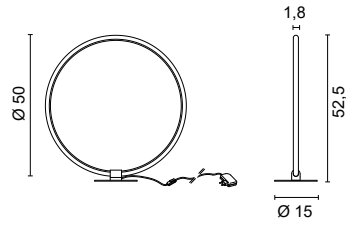

**2514.**\_\_\_/\_\_\_

1,00 Kg

<b>.01</b>	White	
<b>.02</b>	Black	
<b>.25</b>	Golden satin	
<b>.31</b>	Chromed	

<b>/W</b>	4000K	LED 14W	CRI>90	1620lm
<b>/WW</b>	3000K	LED 14W	CRI>90	1530lm
<b>/XW</b>	2700K	LED 14W	CRI>90	1440lm



Mit PUSH DIMM am Kabel

## AUSFÜHRUNGEN CODE

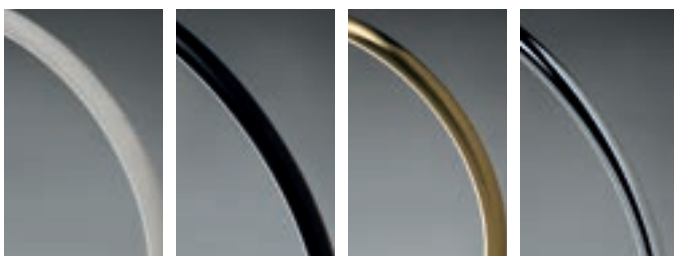

**.01** Weiß

**.02** Schwarz

**.25** Gold satiniert

**.31** Verchromt







# LANCIA TONDA

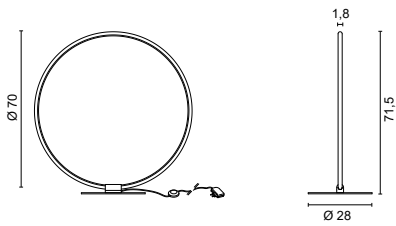

**3513.**\_\_/\_/\_\_\_ 2,00 Kg

<b>.01</b>	White	
<b>.02</b>	Black	
<b>.25</b>	Golden satin	
<b>.31</b>	Chromed	

<b>/W</b>	4000K	LED 20W	CRI>90	2268lm
<b>/WW</b>	3000K	LED 20W	CRI>90	2142lm
<b>/XW</b>	2700K	LED 20W	CRI>90	2016lm



Mit PUSH DIMM am Kabel

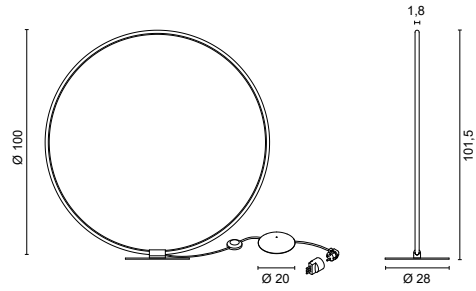

**3514.**\_\_/\_/\_\_\_ 3,90 Kg

<b>.01</b>	White	
<b>.02</b>	Black	

<b>/W</b>	4000K	LED 29W	CRI>90	3240lm
<b>/WW</b>	3000K	LED 29W	CRI>90	3060lm
<b>/XW</b>	2700K	LED 29W	CRI>90	2880lm



Mit PUSH DIMM am Kabel

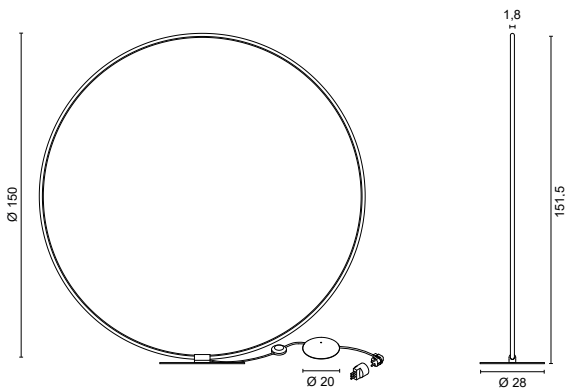

**3515.**\_\_/\_/\_\_\_ 4,50 Kg

<b>.01</b>	White	
<b>.02</b>	Black	

<b>/W</b>	4000K	LED 43W	CRI>90	4860lm
<b>/WW</b>	3000K	LED 43W	CRI>90	4590lm
<b>/XW</b>	2700K	LED 43W	CRI>90	4224lm



Mit PUSH DIMM am Kabel

## AUSFÜHRUNGEN CODE

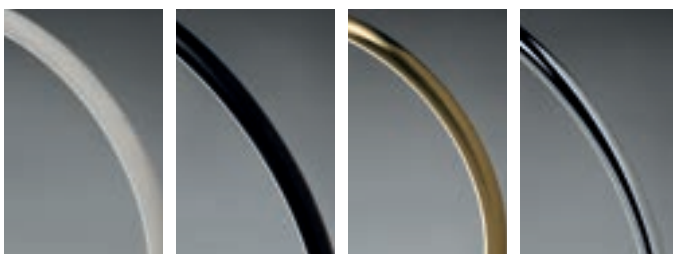

**.01** Weiß    **.02** Schwarz    **.25** Gold satiniert    **.31** Verchromt



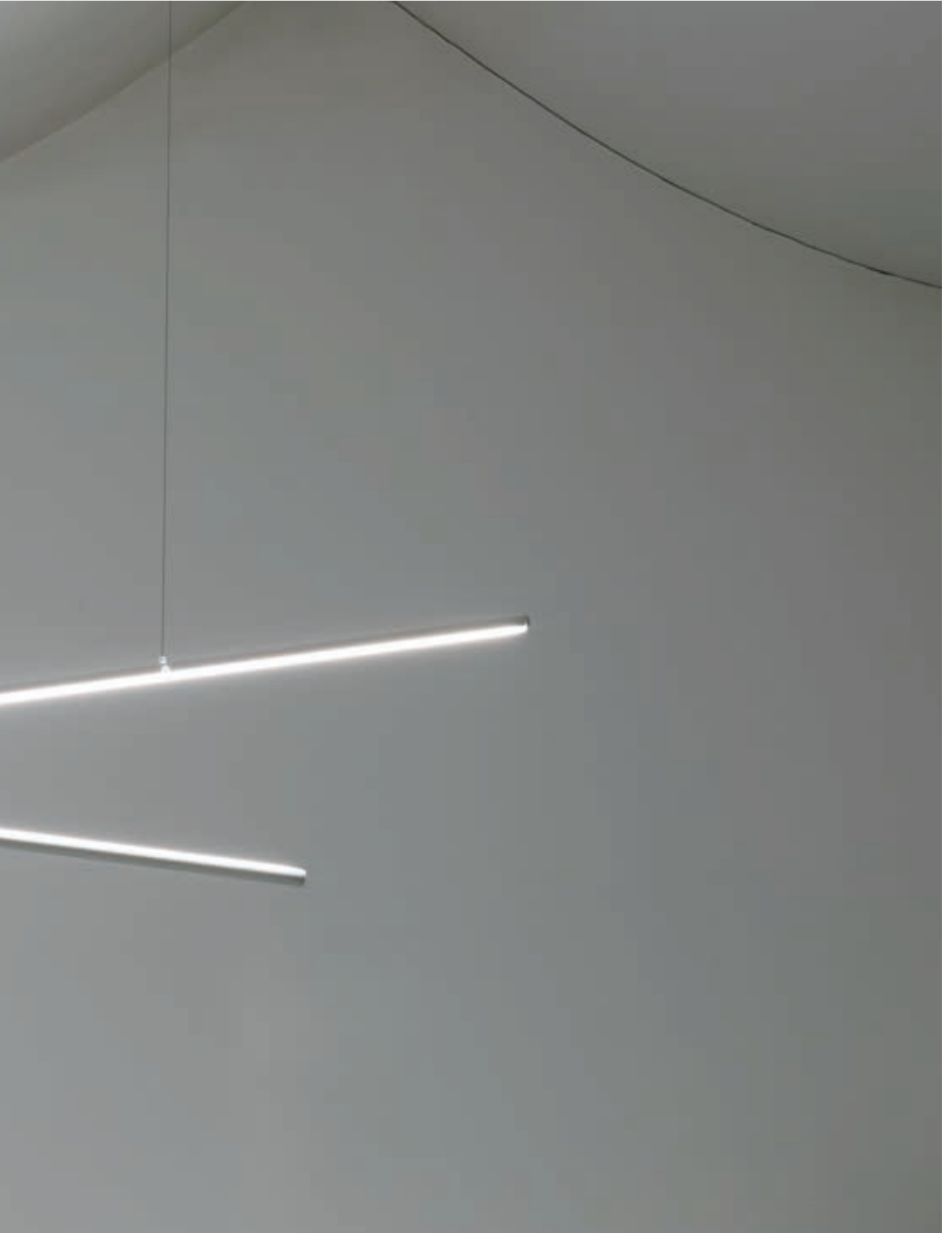





**LANCIA SYSTEM**





# LANCIA SYSTEM

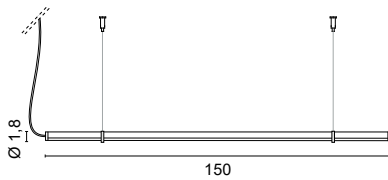

**1539.**\_\_/\_ \_\_ 1,10 Kg

- .01** White
- .02** Black
- .85** Painted silver finishing
- .86** Painted gold finishing
- .87** Painted copper finishing
- .88** Painted bronze finishing

- /W** 4000K LED 27W CRI>90 3390lm
- /WW** 3000K LED 27W CRI>90 3030lm
- /XW** 2700K LED 27W CRI>90 2835lm

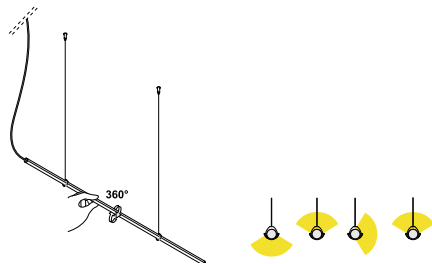

## KUNDENSPEZIFISCHE GRÖSSEN

Tabelle der verfügbaren Längen auf Anfrage.

Ø cm	watt	2700K	lm	3000K	lm	4000K	lm
102	18W	A1539. /100/XW	1890	A1539. /100/WW	2020	A1539. /100/W	2260
127	22,5W	A1539. /125/XW	2362	A1539. /125/WW	2525	A1539. /125/W	2825
152	27W	1539. /XW	2835	1539. /WW	3030	1539. /W	3390
177	31,5W	A1539. /175/XW	3307	A1539. /175/WW	3535	A1539. /175/W	3955
202	36W	A1539. /200/XW	3780	A1539. /200/WW	4040	A1539. /200/W	4520
227	40,5W	A1539. /225/XW	4252	A1539. /225/WW	4545	A1539. /225/W	5085
252	45W	A1539. /250/XW	4725	A1539. /250/WW	5050	A1539. /250/W	5650
277	49,5W	A1539. /275/XW	5197	A1539. /275/WW	5555	A1539. /275/W	6215
302	54W	A1539. /300/XW	5670	A1539. /300/WW	6060	A1539. /300/W	6780

Ausführungen code: **.01 .02 .85 .86 .87 .88**

## AUSFÜHRUNGEN CODE

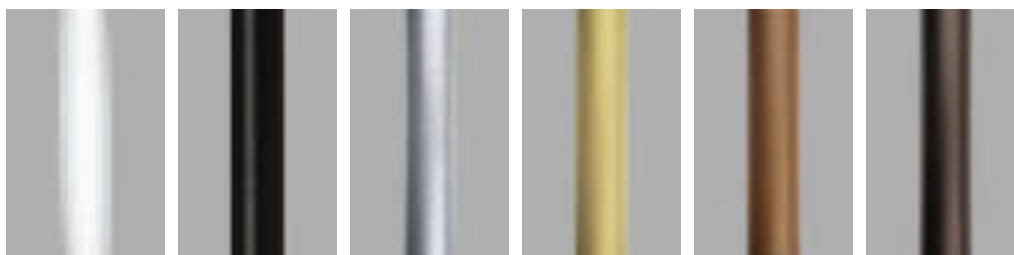

- .01** Weiß
- .02** Schwarz
- .85** Lackiert Silber
- .86** Lackiert Gold
- .87** Lackiert Kupfer
- .88** Lackiert Bronze





Deckenrosetten mit Konverter für Aufhängesysteme siehe Seite 80





MULTI LANCIA SYSTEM









# MULTI LANCIA SYSTEM

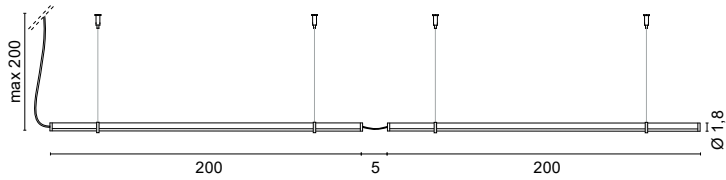

**1670.**\_\_/\_/\_\_\_ 2x200cm 2,80 Kg

- .01 White
- .02 Black

/W	4000K	LED 72W	CRI>90	9040lm
/WW	3000K	LED 72W	CRI>90	8080lm
/XW	2700K	LED 72W	CRI>90	7560lm



Das Befestigungsset für die Aufhängung ist im Lieferumfang der Leuchte enthalten.

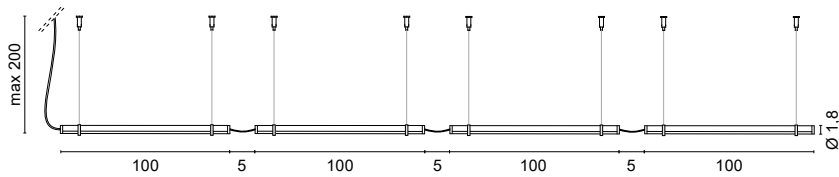
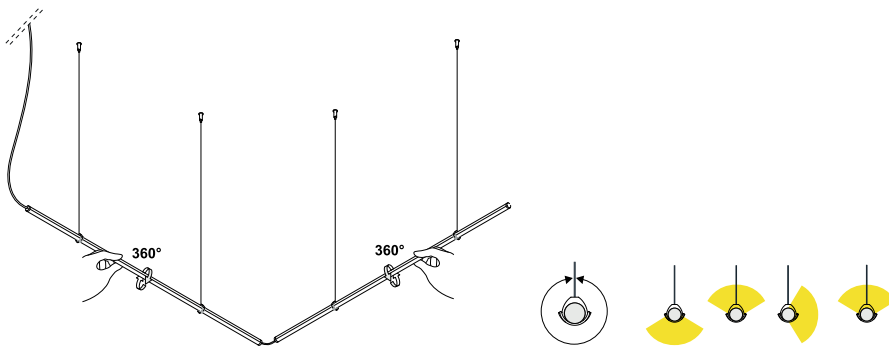

**1671.**\_\_/\_/\_\_\_ 4x100cm 2,80 Kg

- .01 White
- .02 Black

/W	4000K	LED 72W	CRI>90	9040lm
/WW	3000K	LED 72W	CRI>90	8080lm
/XW	2700K	LED 72W	CRI>90	7560lm



Das Befestigungsset für die Aufhängung ist im Lieferumfang der Leuchte enthalten.

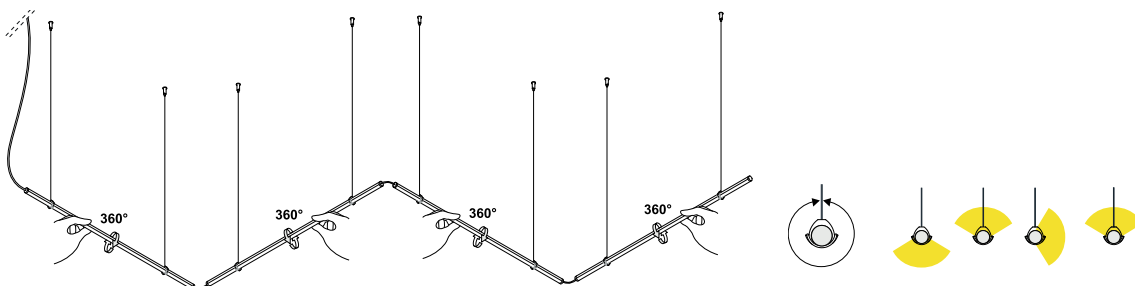





## AUSFÜHRUNGEN CODE

---

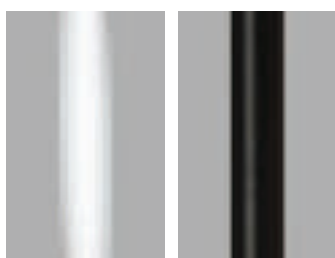

.01 Weiß

.02 Schwarz

---

Deckenrosetten mit Konverter für Aufhängesysteme siehe Seite 80

---





Arch. Stefano Campelli, JRC  
Zighetti Illuminazione - Egoluce

# MULTI LANCIA SYSTEM



## ZUBEHÖR

Befestigungssatz zwischen den Lampen  
**0092**

.00 Clear



Befestigungsclip für die Decke  
**0093**

.00 Clear

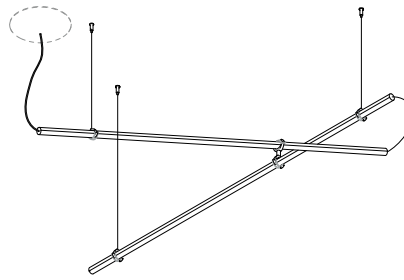

Beispiel einer Installation  
mit 1 Art 0092 + 1 Art 1670.

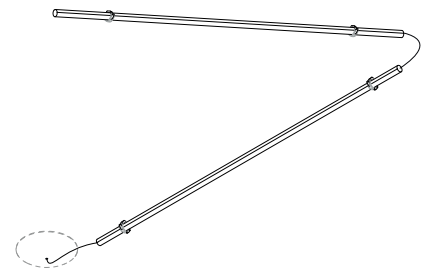

Beispiel einer Installation  
mit 4 art 0093 + 1 art 1670.

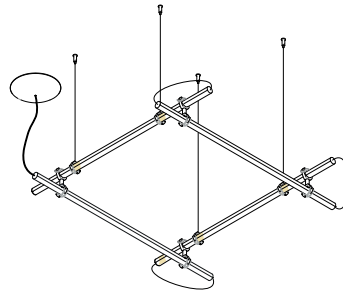

Beispiel einer Installation  
mit 4 art 0092 + 1 art 1671.

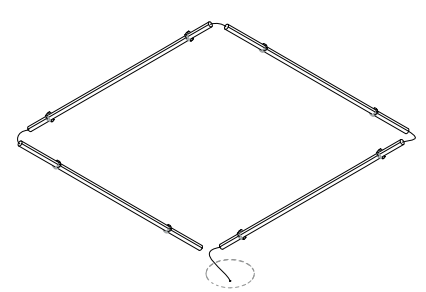

Beispiel einer Installation  
mit 8 art 0093 + 1 art 1671.



Beispiel einer Installation mit  
1 Art 0092 + 1 Art 1670.



Beispiel einer Installation mit  
8 art 0093 + 1 art 1671.



**LANCIA NO LIMITS**







max 600/1000

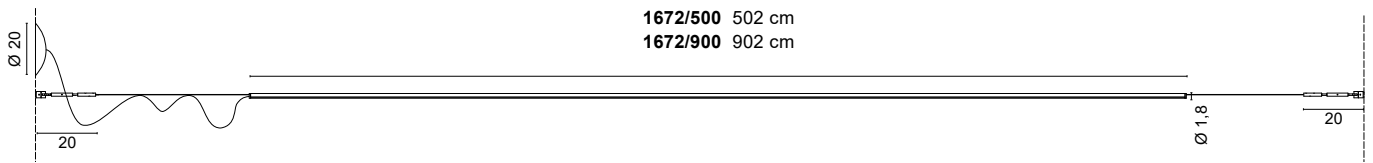

**1672. \_\_ / 500 / \_\_** 3,00 Kg

- .01** White
- .02** Black

<b>/W</b>	4000K	LED 24V 60W	CRI>90	9200lm
<b>/WW</b>	3000K	LED 24V 60W	CRI>90	8250lm
<b>/XW</b>	2700K	LED 24V 60W	CRI>90	7800lm

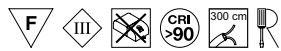

Spanner und Deckenrosetten mit Netzteilen sind separat zu bestellen.

**1672. \_\_ / 900 / \_\_** 5,50 Kg

- .01** White
- .02** Black

<b>/W</b>	4000K	LED 24V 108W	CRI>90	16560lm
<b>/WW</b>	3000K	LED 24V 108W	CRI>90	14850lm
<b>/XW</b>	2700K	LED 24V 108W	CRI>90	14040lm



Spanner und Deckenrosetten mit Netzteilen sind separat zu bestellen.

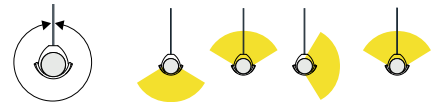

Das Profil kann sich um seine Achse um 360° drehen, um das Licht zu lenken

## ZUBEHÖR



Bausatz  
**0965.31**

2 verchromte Messingspanner mit 2 Stahlseilen L. 6 mt.

Bausatz  
**0965.31/10**

2 verchromte Messingspanner mit 2 Stahlseilen L. 10 mt

Kabelsatz für eine Lampe  
**0991/C**

1 Stahlseil 2 mt  
1 Element zur Kabelbefestigung  
1 Aufhängeschelle



## AUSFÜHRUNGEN CODE

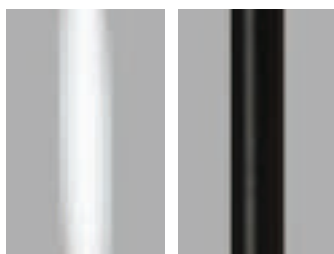

**.01** Weiß

**.02** Schwarz





LANCIA NO LIMITS





LANCIA NO LIMITS





# LANCIA NO LIMITS

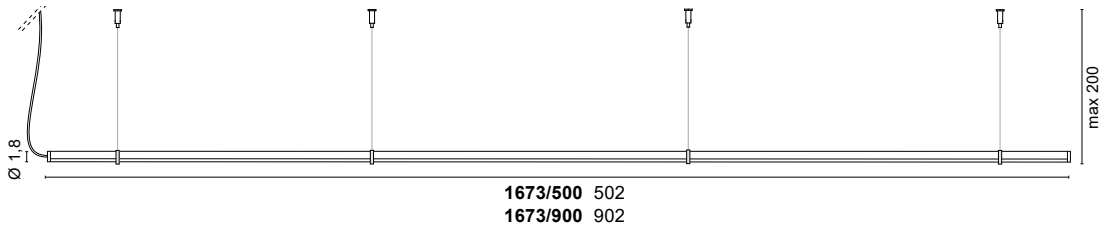

**1673. \_\_ / 500 / \_\_** 4,20 Kg

- .01 White
- .02 Black

<b>/W</b>	4000K	LED 24V 60W	CRI>90	9200lm
<b>/WW</b>	3000K	LED 24V 60W	CRI>90	8250lm
<b>/XW</b>	2700K	LED 24V 60W	CRI>90	7800lm

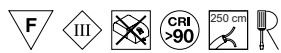

Spanner und Deckenrossetten mit Netzteilen sind separat zu bestellen.

**1673. \_\_ / 900 / \_\_** 6,30 Kg

- .01 White
- .02 Black

<b>/W</b>	4000K	LED 24V 108W	CRI>90	16560lm
<b>/WW</b>	3000K	LED 24V 108W	CRI>90	14850lm
<b>/XW</b>	2700K	LED 24V 108W	CRI>90	14040lm



Spanner und Deckenrossetten mit Netzteilen sind separat zu bestellen.

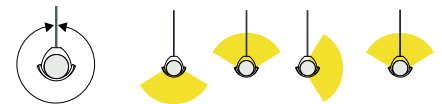

Das Profil kann sich um seine Achse um 360° drehen, um das Licht zu lenken

## ZUBEHÖR



Kabelsatz für eine Lampe

### 0991/C

- 1 Stahlseil 2 mt
- 1 Element zur Kabelbefestigung
- 1 Aufhängeschelle





## AUSFÜHRUNGEN CODE

---

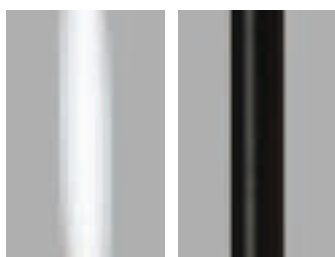

**.01** Weiß

**.02** Schwarz

---

Deckenrosetten mit Konverter für Aufhängesysteme siehe Seite 80

---

# DECKENROSETTEN SYSTEM 24V

LANCIA SYSTEM - MULTI LANCIA SYSTEM - LANCIA NO LIMITS - LANCIA TONDA SYSTEM

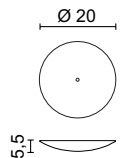

Deckenrosette mit **60W** Konverter 50/60Hz 220-230V

**0990/60...** / \_\_ 0,70Kg

- .01 White
- .02 Black
- .85 Painted silver finishing
- .86 Painted gold finishing
- .87 Painted copper finishing
- .88 Painted bronze finishing

/P	DIMMER		MAX 60W
/V	DIMMER		MAX 60W
/D	DIMMER		MAX 60W

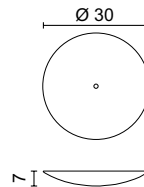

Deckenrosette mit **100W** Konverter 50/60Hz 220-230V

**0990/100...** / \_\_ 1,30Kg

- .01 White
- .02 Black
- .85 Painted silver finishing
- .86 Painted gold finishing
- .87 Painted copper finishing
- .88 Painted bronze finishing

/P	DIMMER		MAX 100W
/V	DIMMER		MAX 100W
/D	DIMMER		MAX 100W

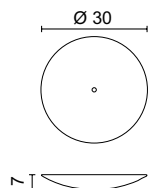

Deckenrosette mit **150W** Konverter 50/60Hz 220-230V

**0990/150...** / \_\_ 1,30Kg

- .01 White
- .02 Black
- .85 Painted silver finishing
- .86 Painted gold finishing
- .87 Painted copper finishing
- .88 Painted bronze finishing

/P	DIMMER		MAX 150W
/V	DIMMER		MAX 150W
/D	DIMMER		MAX 150W

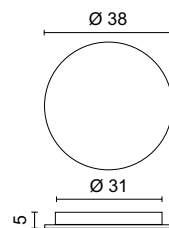

Deckenrosette mit **200W** Konverter 50/60Hz 220-230V

**0990/200...** / \_\_ 2,00 kg

- .01 White
- .02 Black
- .85 Painted silver finishing
- .86 Painted gold finishing
- .87 Painted copper finishing
- .88 Painted bronze finishing

/P	DIMMER		MAX 2x100W
/V	DIMMER		MAX 2x100W
/D	DIMMER		MAX 2x100W

## BEISPIELE FÜR MEHRFACHINSTALLATIONEN

Die Wahl der Deckenrosette hängt vom Gesamtstromverbrauch ab.

### 0990/150

Deckenrosette mit Konverter 150W

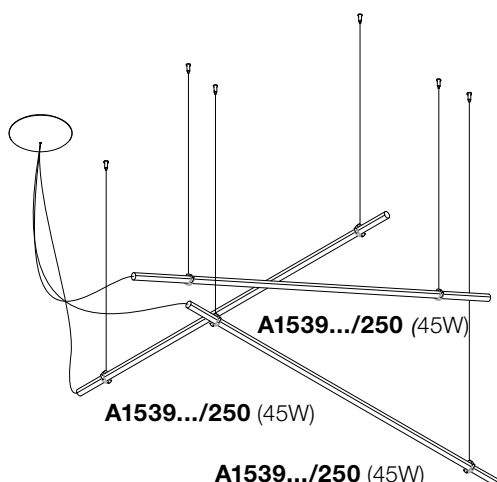

### 0990/60

Deckenrosette mit Konverter 60W

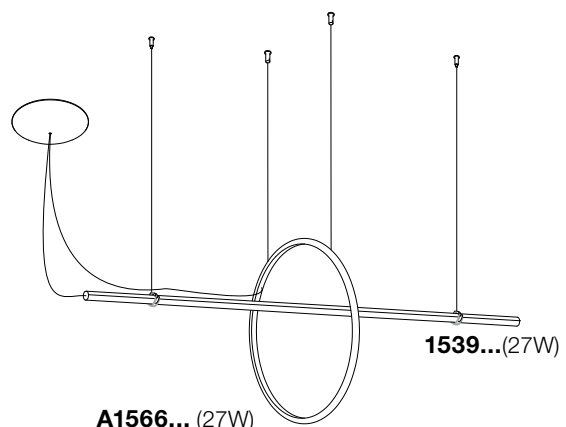

Das Befestigungsset für die Aufhängung ist im Lieferumfang der Leuchte enthalten..







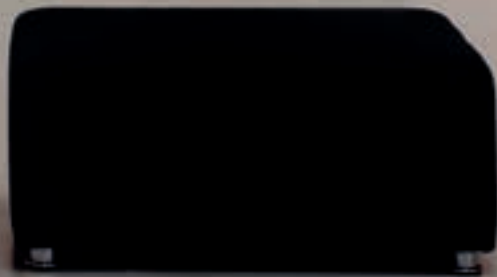

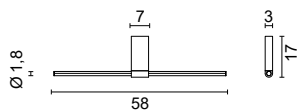

**4567.**\_\_/\_/\_\_\_ 0,80 Kg

<b>.01</b>	White	
<b>.02</b>	Black	
<b>.24</b>	Black chrome	
<b>.25</b>	Golden satin	
<b>.31</b>	Chromed	
<b>.32</b>	Nickel mat	

<b>/W</b>	4000K	LED 9W	CRI>90	1130lm
<b>/WW</b>	3000K	LED 9W	CRI>90	1010lm
<b>/XW</b>	2700K	LED 9W	CRI>90	945lm

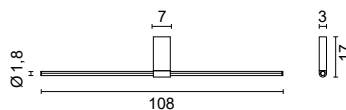

**4568.**\_\_/\_/\_\_\_ 1,00 Kg

<b>.01</b>	White	
<b>.02</b>	Black	
<b>.24</b>	Black chrome	
<b>.25</b>	Golden satin	
<b>.31</b>	Chromed	
<b>.32</b>	Nickel mat	

<b>/W</b>	4000K	LED 18W	CRI>90	2260lm
<b>/WW</b>	3000K	LED 18W	CRI>90	2020lm
<b>/XW</b>	2700K	LED 18W	CRI>90	1890lm

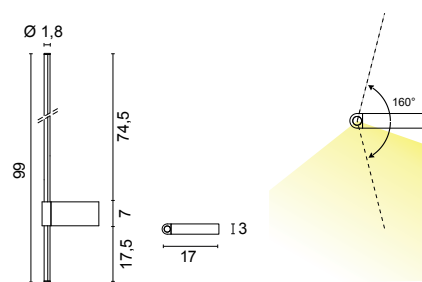
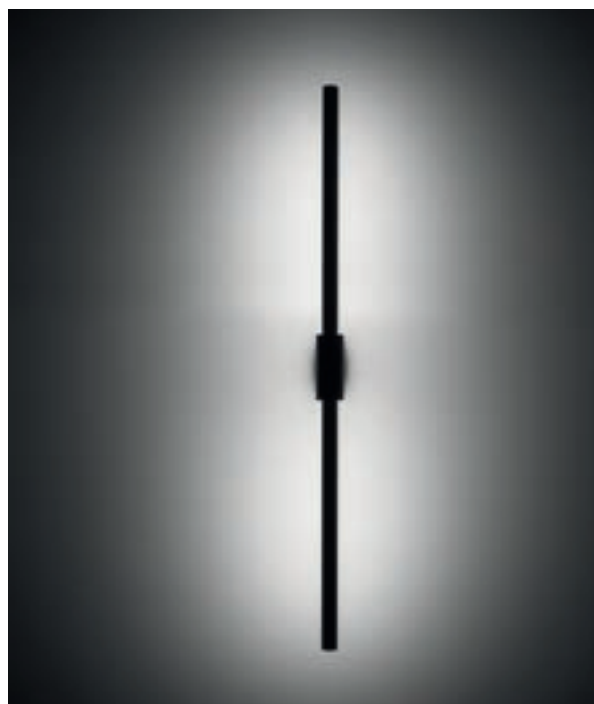

**4569.**\_\_/\_/\_\_\_ 0,90 Kg

<b>.01</b>	White	
<b>.02</b>	Black	
<b>.24</b>	Black chrome	
<b>.25</b>	Golden satin	
<b>.31</b>	Chromed	
<b>.32</b>	Nickel mat	

<b>/W</b>	4000K	LED 16,5W	CRI>90	2072lm
<b>/WW</b>	3000K	LED 16,5W	CRI>90	1852lm
<b>/XW</b>	2700K	LED 16,5W	CRI>90	1732lm



## AUSFÜHRUNGEN CODE

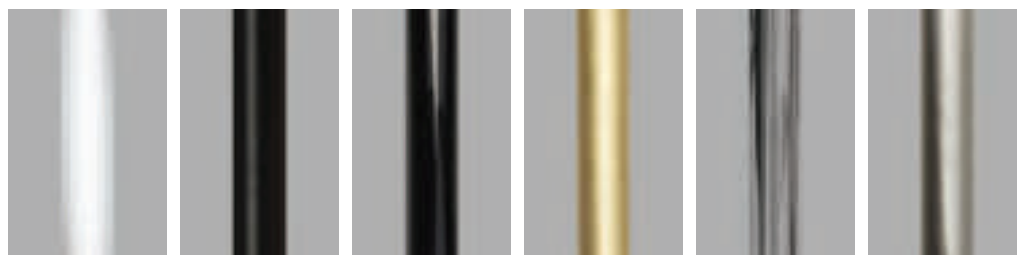

**.01** Weiß

**.02** Schwarz

**.24** Schwarz  
Chrom

**.25** Gold satiniert

**.31** Verchromt

**.32** Nickel matt



Arch. Laura Verdi, DEMO HOTEL  
Ph. Flavio Ricci





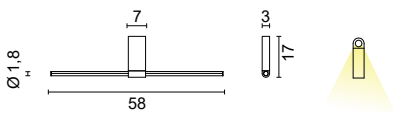

**5567.**\_\_/\_/\_\_\_ 0,80 Kg

<b>.01</b>	White	
<b>.02</b>	Black	
<b>.31</b>	Chromed	

<b>/W</b>	4000K	LED 9W	CRI>90	1130lm
<b>/WW</b>	3000K	LED 9W	CRI>90	1010lm
<b>/XW</b>	2700K	LED 9W	CRI>90	945lm

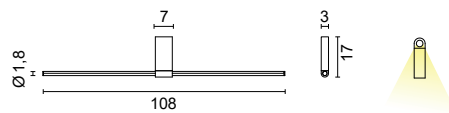
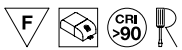

**5568.**\_\_/\_/\_\_\_ 0,80 Kg

<b>.01</b>	White	
<b>.02</b>	Black	
<b>.31</b>	Chromed	

<b>/W</b>	4000K	LED 18W	CRI>90	2260lm
<b>/WW</b>	3000K	LED 18W	CRI>90	2020lm
<b>/XW</b>	2700K	LED 18W	CRI>90	1890lm



## AUSFÜHRUNGEN CODE

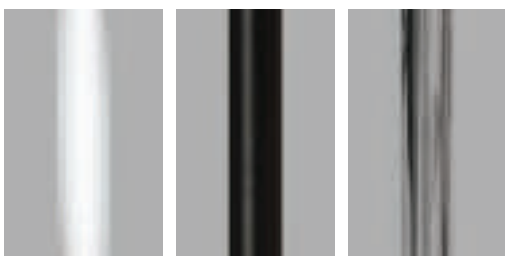

**.01** Weiß

**.02** Schwarz

**.31** Verchromt





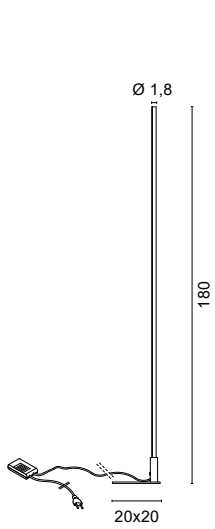

**3522.**\_\_/\_/\_\_\_

2,50 Kg

<b>.01</b>	White	
<b>.02</b>	Black	

<b>/W</b>	4000K	LED 31,5W	CRI>90	3955lm
<b>/WW</b>	3000K	LED 31,5W	CRI>90	3535lm
<b>/XW</b>	2700K	LED 31,5W	CRI>90	3308lm



Mit DIMMER am schwarzen Kabel

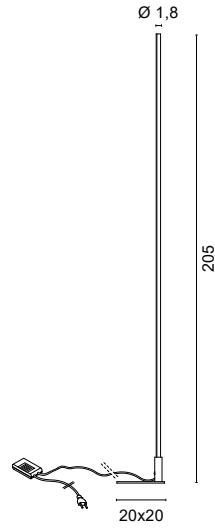

**3523.**\_\_/\_/\_\_\_

2,50 Kg

<b>.01</b>	White	
<b>.02</b>	Black	

<b>/W</b>	4000K	LED 36W	CRI>90	4520lm
<b>/WW</b>	3000K	LED 36W	CRI>90	4040lm
<b>/XW</b>	2700K	LED 36W	CRI>90	3780lm



Mit DIMMER am schwarzen Kabel

## AUSFÜHRUNGEN CODE

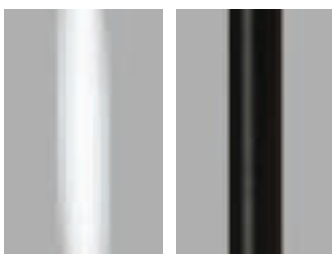

**.01** Weiß

**.02** Schwarz











INDOOR

# FUSION

Design LUX Studio



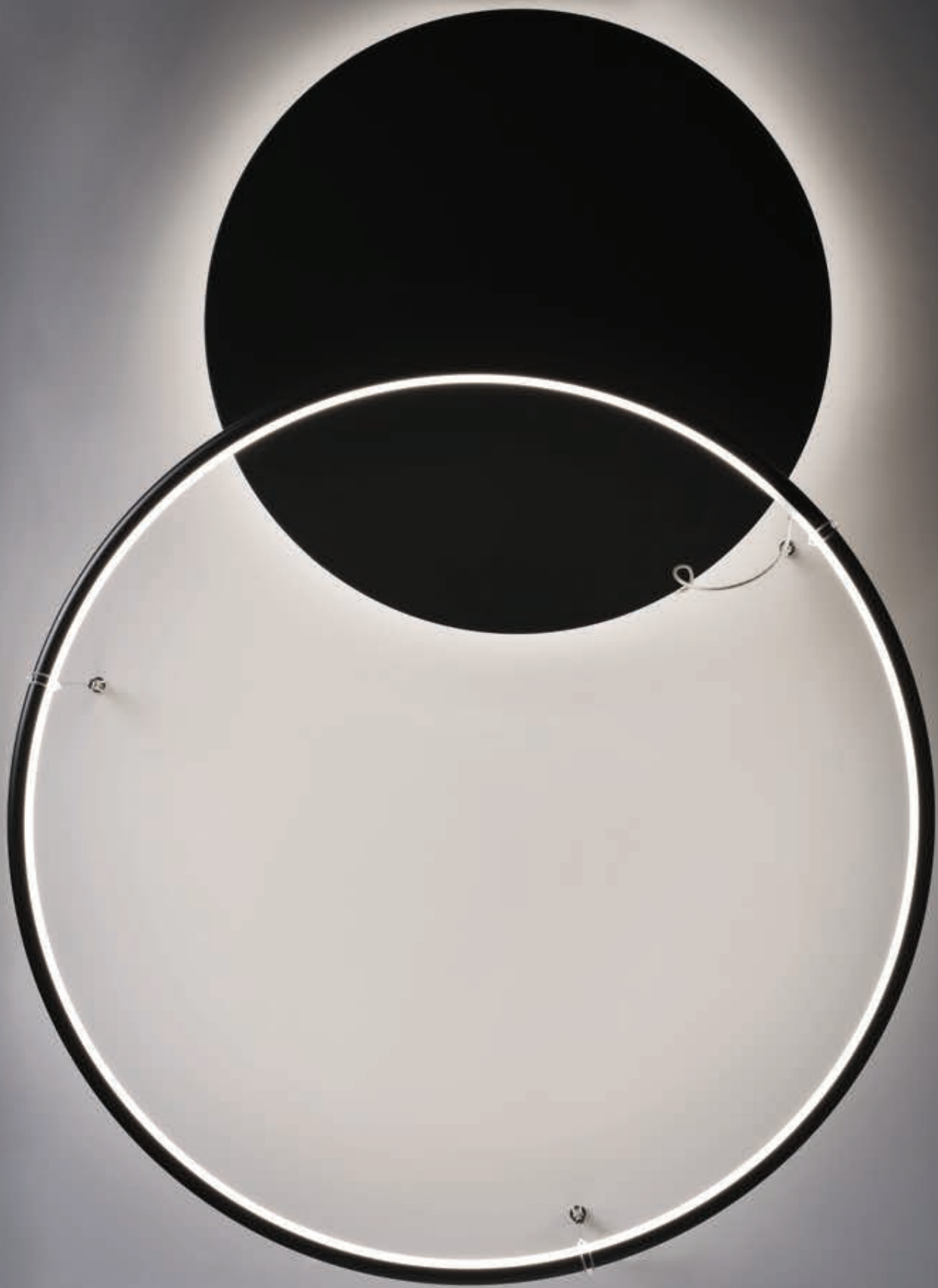



# FUSION



Deckenleuchte, gekennzeichnet durch zwei Elemente, eines mit kreisförmigen Licht und das andere mit diffusem Licht.

Die Besonderheit dieser Lichtaustritte garantiert perfekten Sehkomfort und gleichzeitig eine hervorragende Ausleuchtung des Raumes, in dem die Leuchte platziert ist.

Die Leuchte selbst besteht aus einem Aluminiumkörper und einer Scheibe aus rohem MDF, die lackiert oder in Tafeloptik beschichtet werden kann.



# FUSION

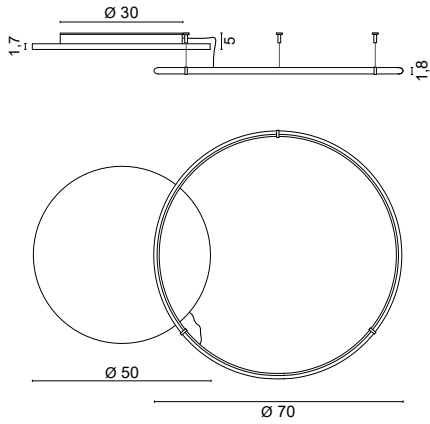

5690.\_ \_ / \_ \_

2,60 Kg

.01.01	White / White	
.14.02	Blackboard / Black	
.14.85	Blackboard / Painted Silver	
.14.86	Blackboard / Painted Gold	
.14.87	Blackboard / Painted Copper	
.14.88	Blackboard / Painted Bronze	

/W	4000K	LED 52,8W	6586lm
/WW	3000K	LED 52,8W	5892lm
/XW	2700K	LED 52,8W	5529lm

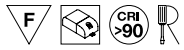

DALI - PUSH - 1...10 - TRIAC Dimmen auf Anfrage

## AUSFÜHRUNGEN CODE



<b>.01.01</b>	<b>.14.02</b>	<b>.14.85</b>	<b>.14.86</b>	<b>.14.87</b>	<b>.14.88</b>
Weiß	Schultafel	Schultafel	Schultafel	Schultafel	Schultafel
Weiß	Schwarz	Lackiert Silber	Lackiert Gold	Lackiert Kupfer	Lackiert Bronze

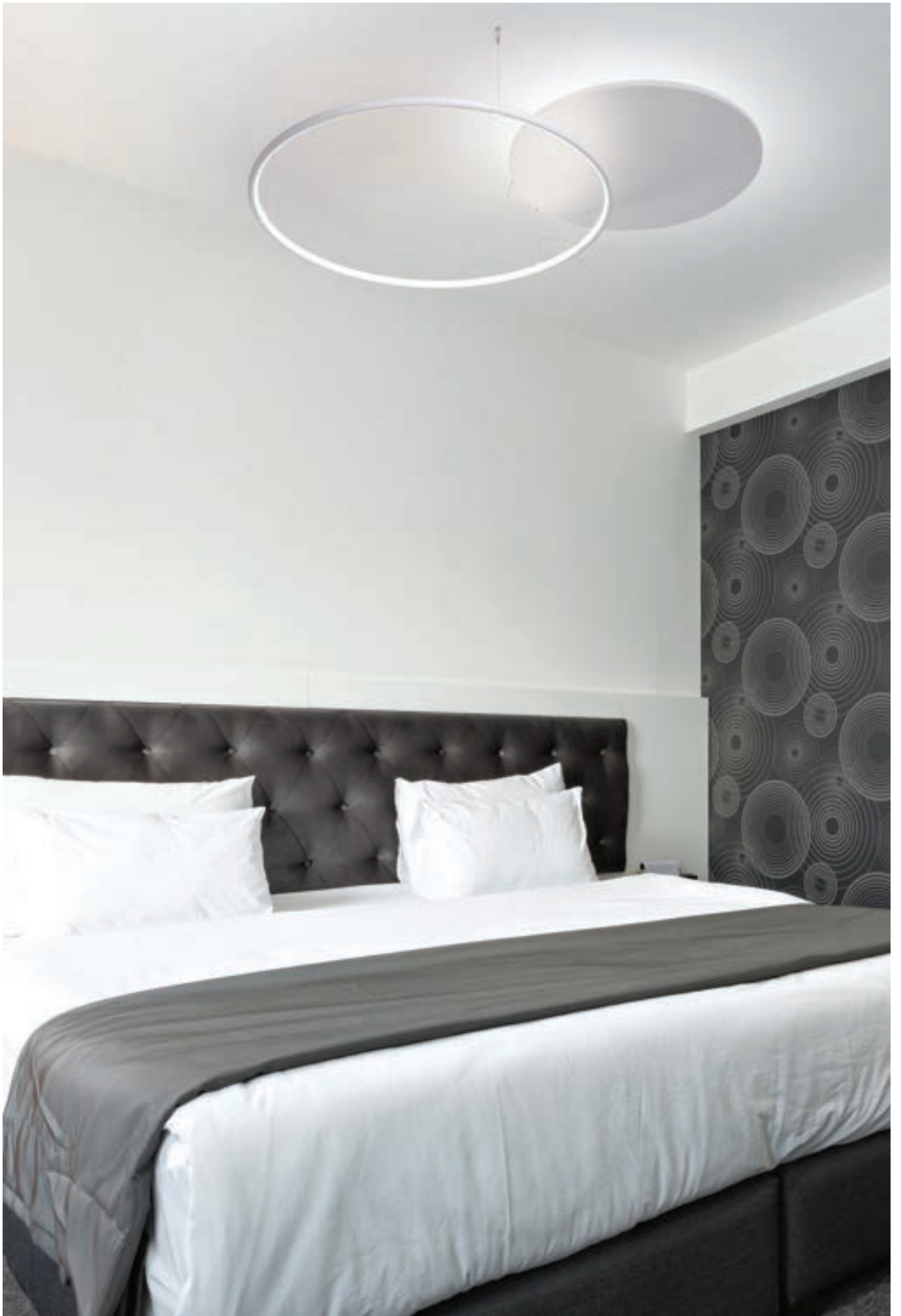



INDOOR

# MOONLIGHT

Design ABS Studio





11



# MOONLIGHT



Decken- oder Wandleuchten mit radialem Licht, gekennzeichnet durch eine Frontscheibe aus MDF, die mit Wasserbasis oder alternativer Farbe lackiert werden kann.

Erhältlich in drei Größen, die kleinste und die mittlere erlaubt mittlerweile auch die Spiegelscheibenlösung. Obwohl die Versorgung von einem einzigen Versorgungspunkt erfolgt, ermöglicht die Verbindung zwischen verschiedenen Armaturen durch das separat zu bestellende Spezialset (Art.0963) mehrere Zusammensetzungen.

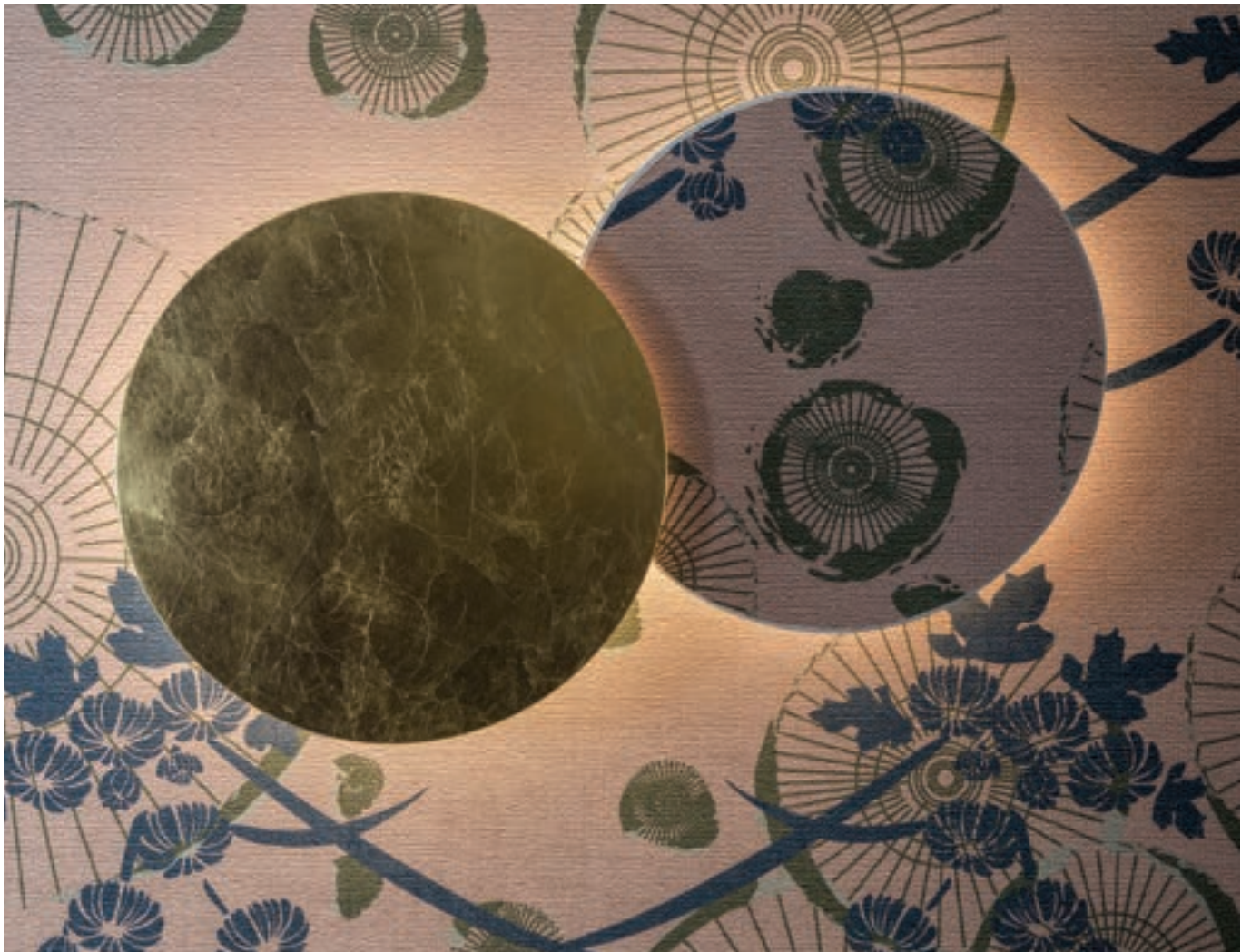

*Arch. Laura Verdi, DEMO HOTEL  
Ph. Flavio Ricci*

# MOONLIGHT

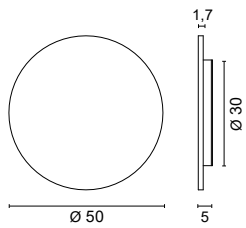

**4582.**\_\_/\_/\_\_\_

4,00 Kg

.01	White	
.14	Blackboard	
.29	Gold leaf	
.30	Silver Leaf	
.56	Mirror	

/W	4000K	LED 15W	CRI>90	1840lm
/WW	3000K	LED 15W	CRI>90	1650lm
/XW	2700K	LED 15W	CRI>90	1560lm

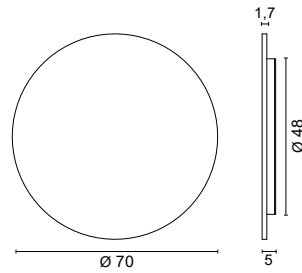

**4583.**\_\_/\_/\_\_\_

7,00 Kg

.01	White	
.14	Blackboard	
.29	Gold leaf	
.30	Silver Leaf	
.56	Mirror	

/W	4000K	LED 24W	CRI>90	2944lm
/WW	3000K	LED 24W	CRI>90	2640lm
/XW	2700K	LED 24W	CRI>90	2496lm

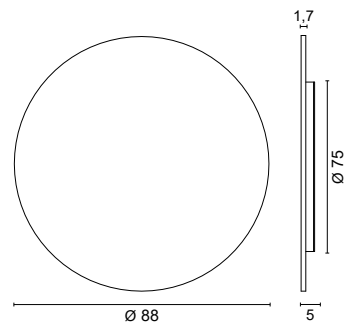

**4620.**\_\_/\_/\_\_\_

9,00 Kg

.01	White	
.14	Blackboard	
.29	Gold leaf	
.30	Silver Leaf	

/W	4000K	LED 33W	CRI>90	4150lm
/WW	3000K	LED 33W	CRI>90	3700lm
/XW	2700K	LED 33W	CRI>90	3460lm



Art.4620 kann in mehreren Installationen verwendet werden, solange sie als Wandleuchte positioniert ist

## ZUBEHÖR

Bausatz für Überlappung nur für Art.4582-4583

**0963**

.01	White	
-----	-------	--

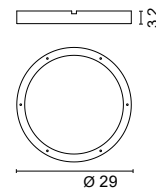

## AUSFÜHRUNGEN CODE

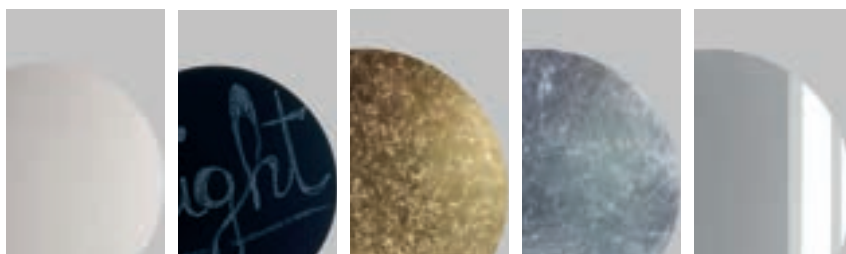

.01	Rohes weiß zum Streichen	.14	Schultafel	.29	Blattgold	.30	Blattsilber	.56	Spiegel Wandmontage
-----	--------------------------	-----	------------	-----	-----------	-----	-------------	-----	---------------------



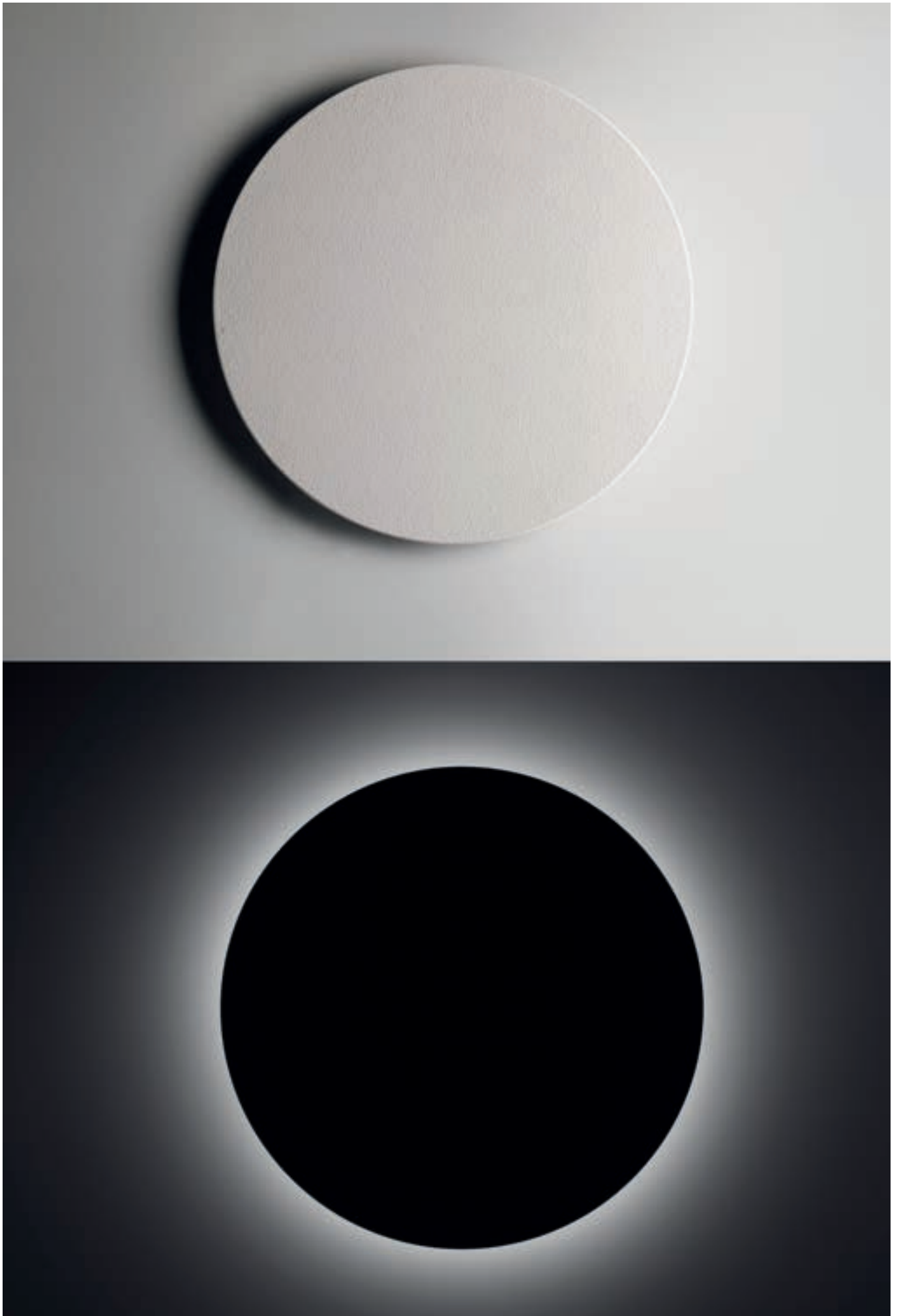





Arch. Laura Verdi, DEMO HOTEL  
Ph. Flavio Ricci





Arch. Laura Verdi, DEMO HOTEL  
Ph. Flavio Ricci

**MOONLIGHT**









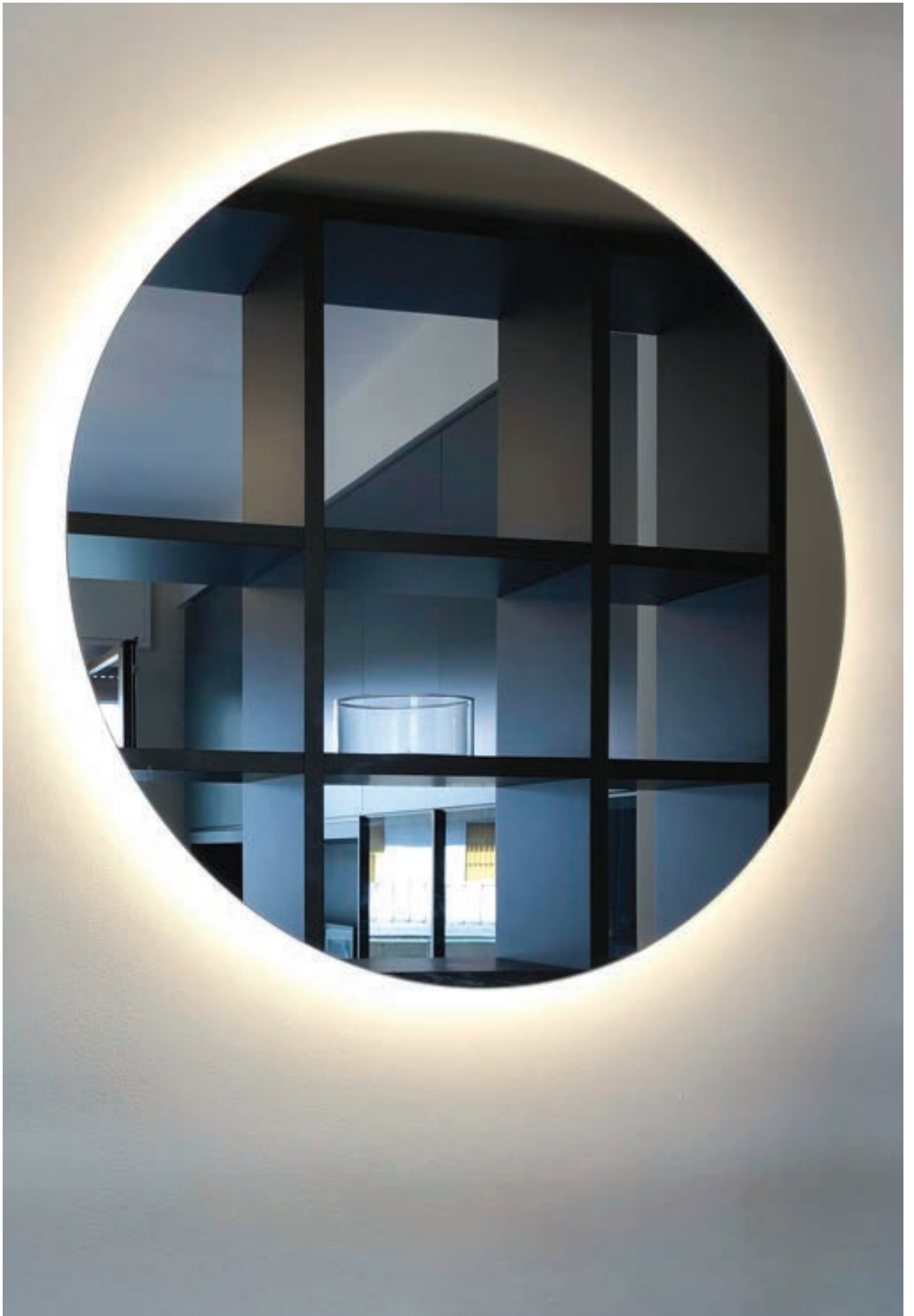

## BEISPIELE FÜR EINZEL UND MEHRFACHINSTALLATIONEN

---

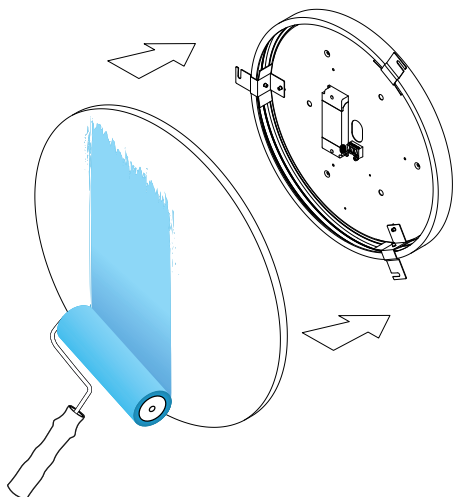

## BEISPIELE FÜR EINZEL- UND MEHRFACHINSTALLATIONEN

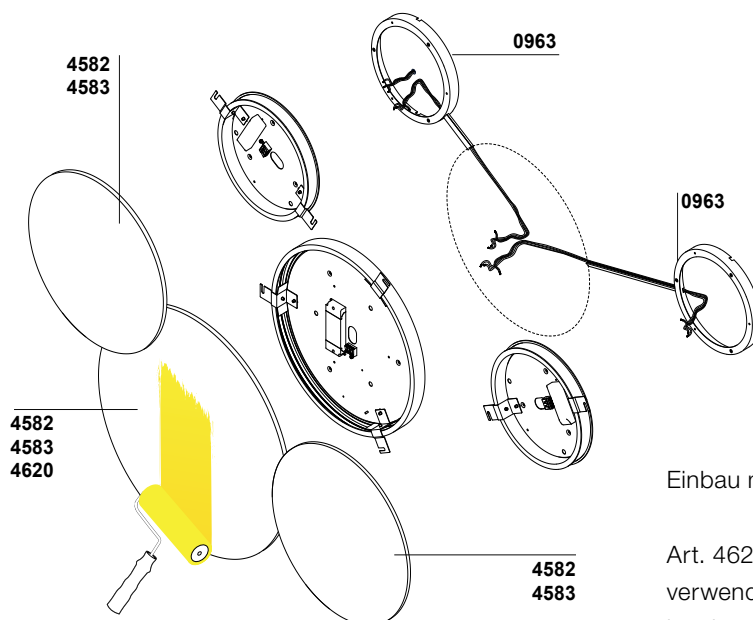
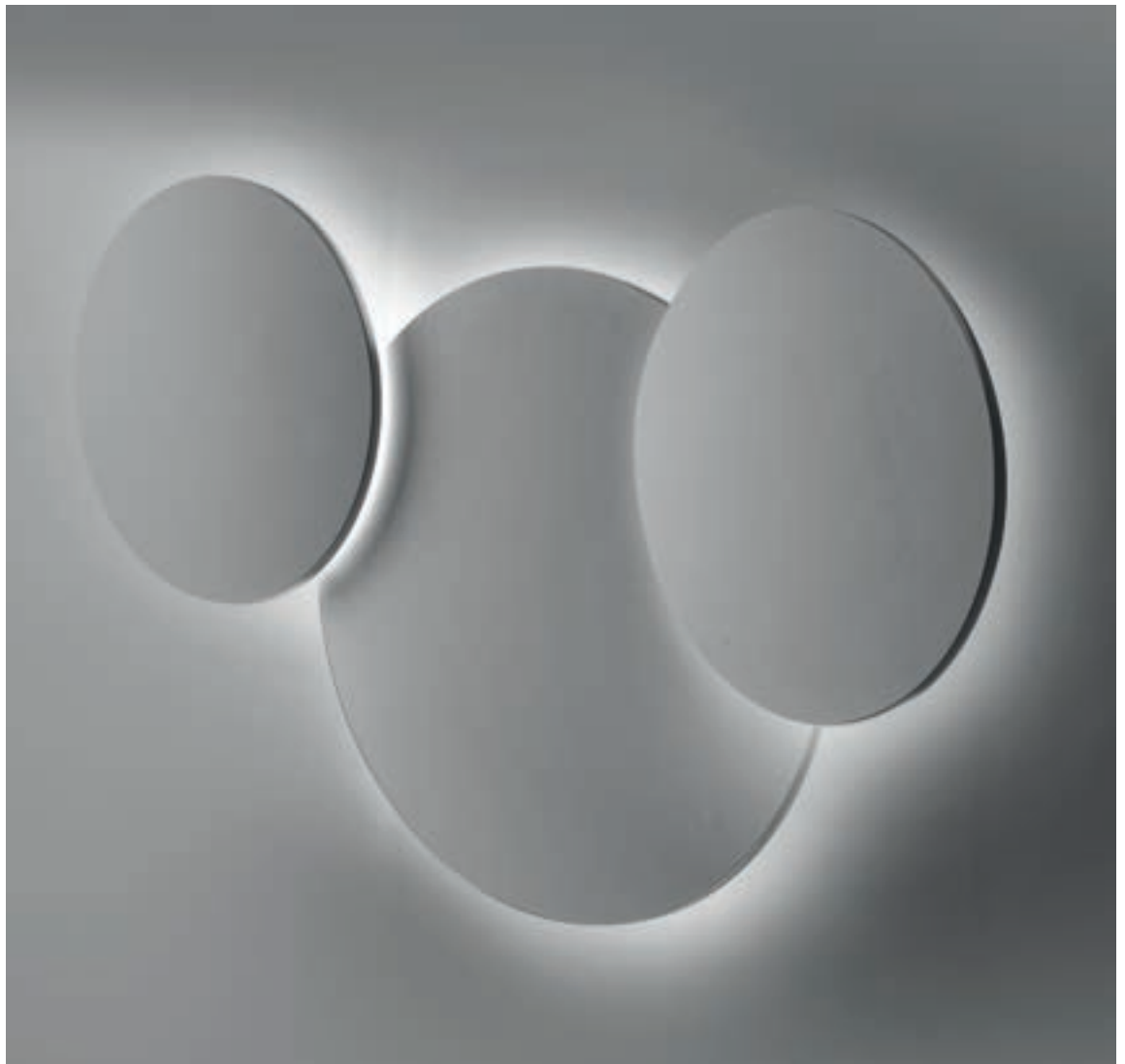

Einbau mit Abstandshaltern Art. 0963

Art. 4620 kann in mehreren Installationen verwendet werden, solange sie als Wandleuchte positioniert ist.



**INDOOR**

# **TULIPANO**

Design LUX Studio





# TULIPANO



System kleiner Pendelleuchten mit diffusem oder direktem Licht. Die Körper sind aus Aluminium, die Diffusoren aus geblasenem und geätztem Opalglas oder aus geformtem Metall.

Die Systeme sind modular in verschiedenen Konfigurationen entsprechend der gewählten Rosetten. Mit den radialen Überdachungen und den verfügbaren Optionen können "Kaskaden"- oder lineare Lösungen bis zu 12 Elementen, aber auch komplexere und aktuellere Konfigurationen erstellt werden.

Die geringen Abmessungen und das essentielle Design, kombiniert mit der Vielseitigkeit der Kompositionen, machen das Tulipano-System für den Einsatz in vielen Kontexten geeignet.



# TULIPANO

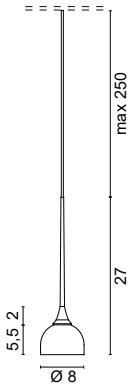

1680.\_.\_/\_.\_

0,15 Kg

.02	Black / In white	■
.25	Golden satin / In white	■
/W	4000K LED 3W	on request
/WW	3000K LED 3W	315lm
/XW	2700K LED 3W	278lm

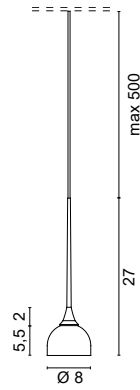

1682.\_.\_/\_.\_

0,25 Kg

.02	Black / In white	■
.25	Golden satin / In white	■
/W	4000K LED 3W	on request
/WW	3000K LED 3W	315lm
/XW	2700K LED 3W	278lm

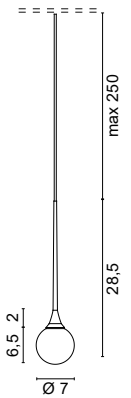

1681.\_.\_/\_.\_

0,20 Kg

.02	Black	■
.25	Golden satin	■
/W	4000K LED 3W	on request
/WW	3000K LED 3W	315lm
/XW	2700K LED 3W	278lm

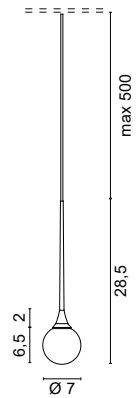

1683.\_.\_/\_.\_

0,30 Kg

.02	Black	■
.25	Golden satin	■
/W	4000K LED 3W	on request
/WW	3000K LED 3W	315lm
/XW	2700K LED 3W	278lm



## AUSFÜHRUNGEN CODE



.02 Schwarz

.25 Gold satiniert





Deckenrosetten mit Konverter für Aufhängesysteme siehe Seite 126





*Hotel Langrein  
Ph. Hannes Niederkofler*

# ZUBEHÖR UND DECKENROSETTEN FÜR KOMPOSITIONEN



Deckenbaldachin für Aufhängung mit Konverter ohne Kabel - 1 Lampe

**IN** 50/60Hz 220-240V

**OUT** 350mA DC

**0614/1**      Ø 9,3cm H 3cm      0,13 Kg

.01	White	■
.02	Black	■



Deckenbaldachin für Aufhängung mit Konverter ohne Kabel - 2 Lampen

**IN** 50/60Hz 220-240V

**OUT** 350mA DC

**0614/2**      Ø 12,5cm H 3cm      0,20 Kg

.01	White	■
.02	Black	■

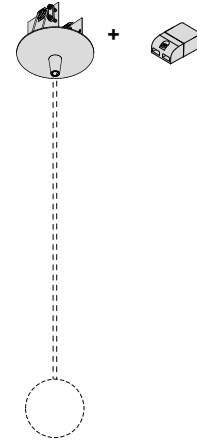

Gipskartonplatten Deckenrosette mit Konverter - 1 Lampe

**IN** 50/60Hz 220-240V

**OUT** 350mA DC

**0614/R**      Ø 9cm      0,15 Kg

.01	White	■
.02	Black	■

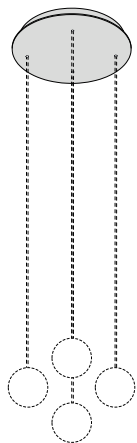

Baldachin mit Konverter 4 Lampen Dimmbar auf Anfrage

**IN** 50/60Hz 220-240V

**OUT** 350mA DC

**0614/4**      Ø 20cm H 3,5cm      1,20 Kg

.01	White	■
.02	Black	■

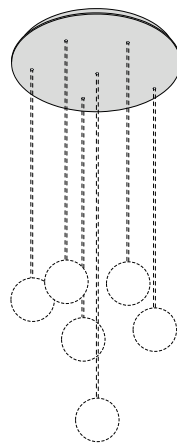

Baldachin mit Konverter 6 Lampen Dimmbar auf Anfrage

**IN** 50/60Hz 220-240V

**OUT** 350mA DC

**0614/6**      Ø 27cm H 3,5cm      1,20 Kg

.01	White	■
.02	Black	■

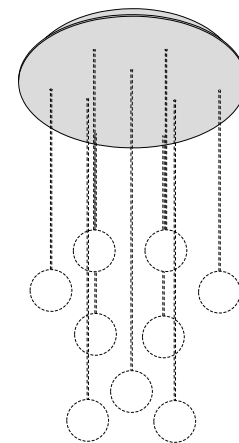

Baldachin mit Konverter 9 Lampen Dimmbar auf Anfrage

**IN** 50/60Hz 220-240V

**OUT** 350mA DC

**0614/9**      Ø 38cm H 3,5cm      2,40 Kg

.01	White	■
.02	Black	■





# ZUBEHÖR UND DECKENROSETTEN FÜR KOMPOSITIONEN KREISFÖRMIG

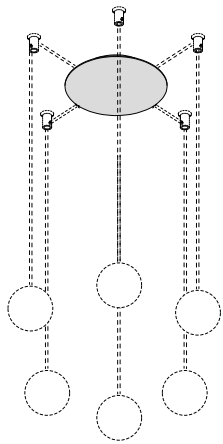

Baldachin mit Konverter 3-6 Lampen  
PUSH, DALI, 1...10V Dimmung  
auf Anfrage

**IN** 50/60Hz 220-240V

**OUT** 350mA DC

**0615/6**      Ø 27cm H 3,5cm      0,50 Kg

<b>.01</b>	White	■
<b>.02</b>	Black	■

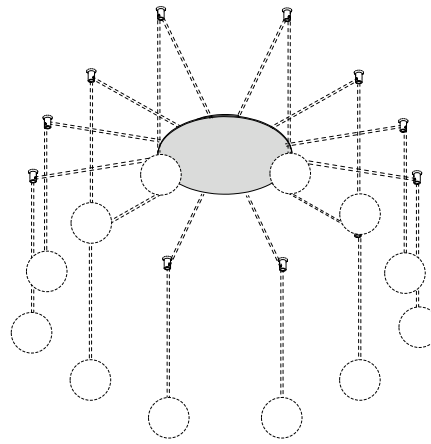

Baldachin mit Konverter 7-12 Lampen  
PUSH, DALI, 1...10V Dimmen  
auf Anfrage

**IN** 50/60Hz 220-240V

**OUT** 350mA DC

**0615/12**      Ø 38cm H 4cm      1,80 Kg

<b>.01</b>	White	■
<b>.02</b>	Black	■



## ZUBEHÖR

Ring

**0304**

Metallring für Kompositionen von 3 bis 6 Lampen.  
Ø 50cm H 1cm.

<b>.01</b>	White	■
<b>.02</b>	Black	■

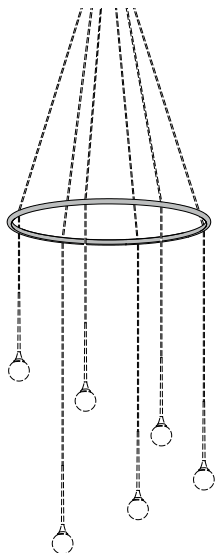

Metallbogen

**0302**

Metallbogen für Kompositionen mit 2 Lampen  
Ø 50cm H 1cm.

<b>.02</b>	White	■
<b>.25</b>	Golden satin	■

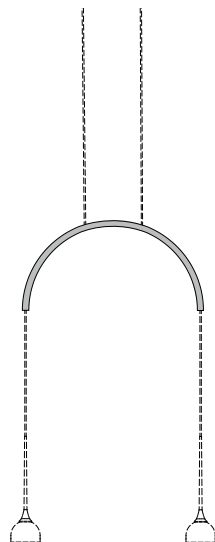

Element

**0612**

1 Verbindungselement  
Ø 1,4cm H 2,2cm.

<b>.01</b>	White	■
<b>.02</b>	Black	■

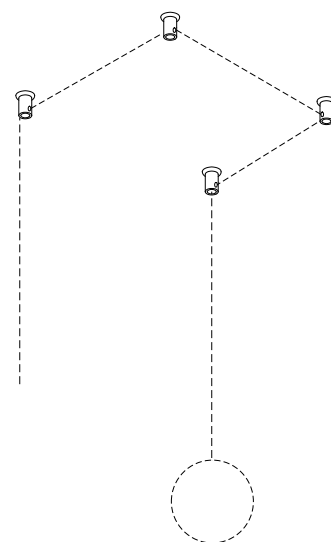



# TULIPANO







# ZUBEHÖR UND DECKENROSETTEN FÜR KOMPOSITIONEN LINEAR

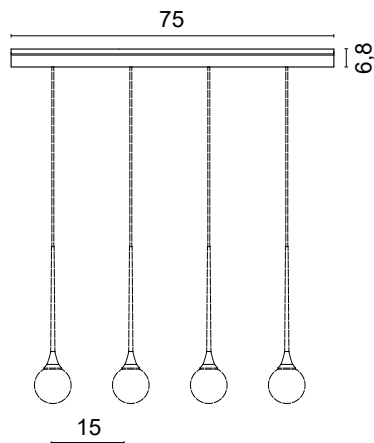

Baldachin mit Konverter 4 Lampen.  
PUSH oder DALI Dimmen auf Anfrage.

**IN** 50/60Hz 220-240V

**OUT** 350mA DC

**0616/4** L 73cm H 6,8cm 1,10 Kg

- .01 White
- .02 Black

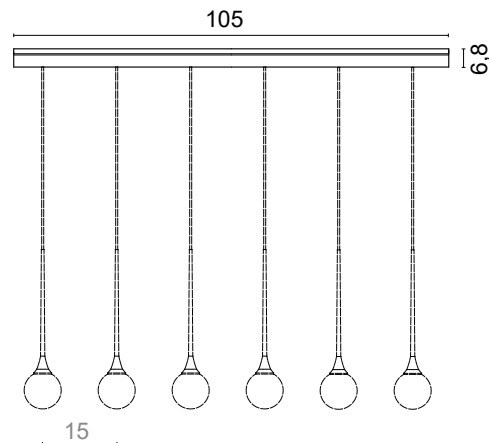

Baldachin mit Konverter 6 Lampen.  
PUSH oder DALI Dimmen auf Anfrage.

**IN** 50/60Hz 220-240V

**OUT** 350mA DC

**0616/6** L 109cm H 6,8cm 1,30 Kg

- .01 White
- .02 Black

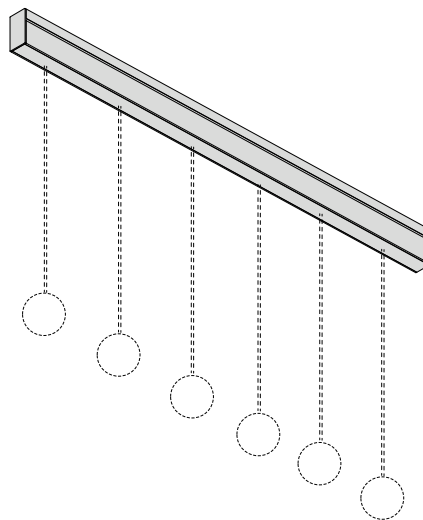
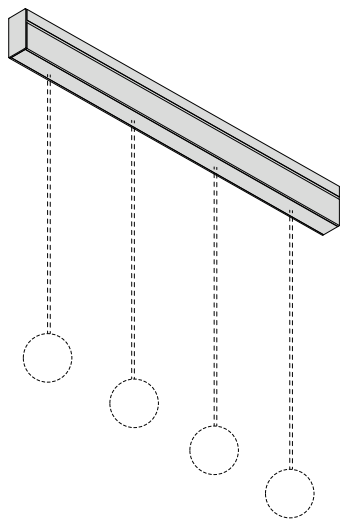

## ZUBEHÖR

Bausatz  
**0305**

Steckverbinder mit Drähten.

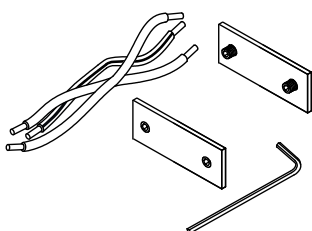



# TULIPANO







**INDOOR**

# IRIS

Design U.T. EgoLuce







Sammlung von Direktlichtlampen. Die Korpusse sind aus Aluminium, ebenso wie die kleinen verstellbaren Strahler, die entworfen wurden, um die Qualität des Akzentlichts optimal zu nutzen. Die integrierte COB-LED-Quelle mit Reflektor bietet eine sehr hohe Effizienz und garantiert gleichzeitig dank der rückwärtigen Position perfekten Sehkomfort. Die Bodenversion zeichnet sich durch einen breiten und schlanken Bogen aus, der eine Höhe von 2,10 Metern erreicht und die Positionierung der beiden Strahler in der Mitte eines Tisches oder auf einem Sofasitz ermöglicht.

Die linearen und runden Aufhängungslösungen sind mit drei verstellbaren Strahlern ausgestattet, die es Ihnen ermöglichen, das Licht dorthin zu lenken, wo Sie es möchten. Mit ihrem eleganten und modernen Design sind sie ideal für die Beleuchtung von Ausstellungsräumen, Ausstellungsräumen, aber auch Wohnumgebungen, Tischen in Besprechungs- und Empfangsräumen.



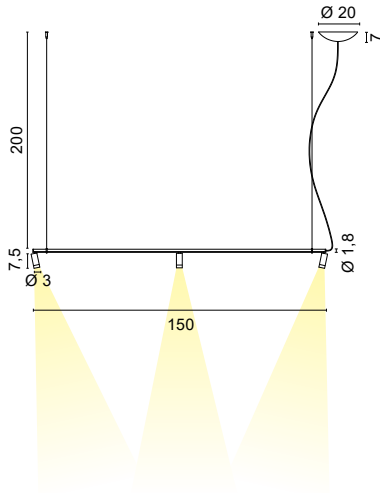

1678.\_ \_ / \_ \_

1,40 Kg

- .01 White
- .02 Black

/W	4000K	LED 17,7W	3180lm	2640lm (out)
/WW	3000K	LED 17,7W	3090lm	2665lm (out)
/XW	2700K	LED 17,7W	2907lm	2412lm (out)

**/DIM** **PUSH - 1...10 dimming**

/W	4000K	LED 17,7W	3180lm	2640lm (out)
/WW	3000K	LED 17,7W	3090lm	2665lm (out)
/XW	2700K	LED 17,7W	2907lm	2412lm (out)

**/DALI** **DALI dimming**

/W	4000K	LED 17,7W	3180lm	2640lm (out)
/WW	3000K	LED 17,7W	3090lm	2665lm (out)
/XW	2700K	LED 17,7W	2907lm	2412lm (out)



Verschiedene Optiken auf Anfrage

## ZUBEHÖR

Wabenraster-Aufsatz

**0267/S**

- .01 White
- .02 Black



## AUSFÜHRUNGEN CODE



.01 Weiß

.02 Schwarz



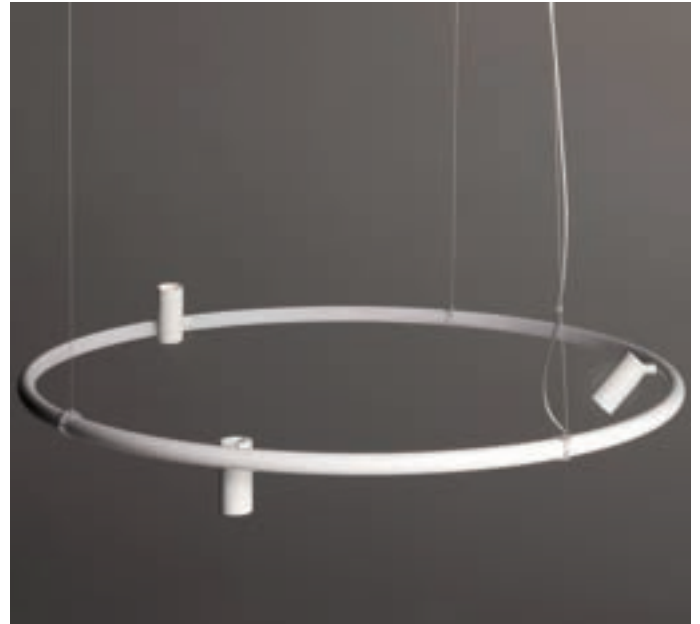
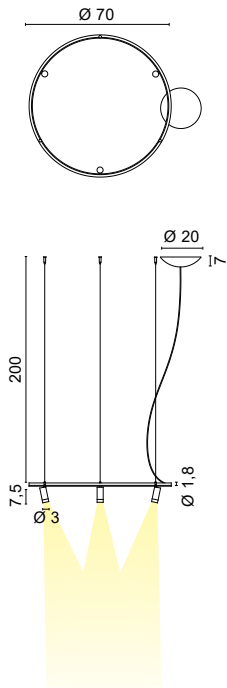

1679. \_\_ / \_\_

1,40 Kg

- .01 White
- .02 Black

/W	4000K	LED 17,7W	3180lm	2640lm (out)
/WW	3000K	LED 17,7W	3090lm	2665lm (out)
/XW	2700K	LED 17,7W	2907lm	2412lm (out)

**/DIM** **PUSH - 1...10 dimming**

/W	4000K	LED 17,7W	3180lm	2640lm (out)
/WW	3000K	LED 17,7W	3090lm	2665lm (out)
/XW	2700K	LED 17,7W	2907lm	2412lm (out)

**/DALI** **DALI dimming**

/W	4000K	LED 17,7W	3180lm	2640lm (out)
/WW	3000K	LED 17,7W	3090lm	2665lm (out)
/XW	2700K	LED 17,7W	2907lm	2412lm (out)

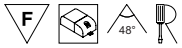

Verschiedene Optiken auf Anfrage

## ZUBEHÖR

Wabenraster-Aufsatz

**0267/S**

- .01 White
- .02 Black



## AUSFÜHRUNGEN CODE



.01 Weiß

.02 Schwarz



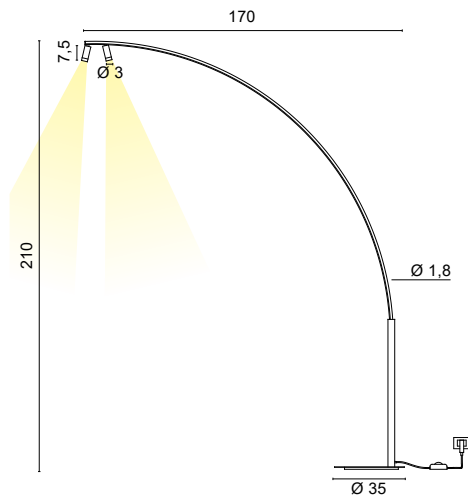

**3533.**\_\_/\_/\_\_

7,00 Kg

- .01** White ■
- .02** Black ■

<b>/W</b>	4000K	LED 11,8W	2120lm	1760lm (out)
<b>/WW</b>	3000K	LED 11,8W	2060lm	1710lm (out)
<b>/XW</b>	2700K	LED 11,8W	1938lm	1608lm(out)

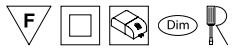

Mit PUSH DIMMER am schwarzen Kabel



## ZUBEHÖR

Wabenraster-Aufsatz

**0267/S**

- .01** White ■
- .02** Black ■

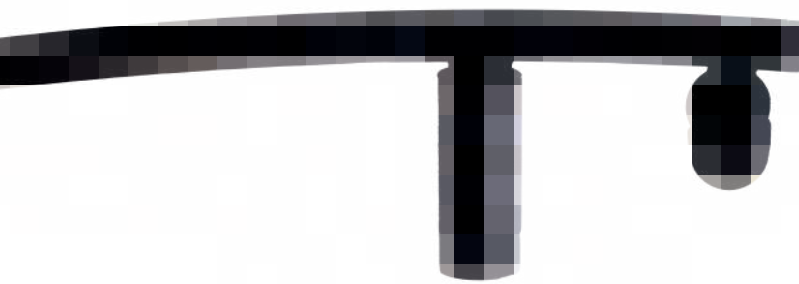

## AUSFÜHRUNGEN CODE



**.01** Weiß

**.02** Schwarz









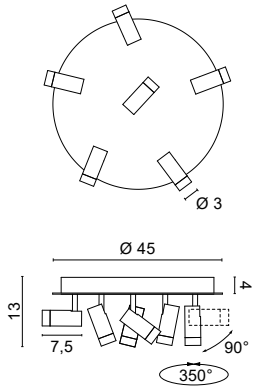

**5680.**\_\_/\_

2,80 Kg

.01	White	■
.02	Black	■
/W	4000K /25° /48° /63°	LED 35,4W 6360lm 5280lm (out)
/W	4000K /ST Satin	LED 35,4W 6360lm 4896lm (out)
/WW	3000K /25° /48° /63°	LED 35,4W 6180lm 5130lm (out)
/WW	3000K /ST Satin	LED 35,4W 6180lm 4758lm (out)
/XW	2700K /25° /48° /63°	LED 35,4W 5814lm 4824lm (out)
/XW	2700K /ST Satin	LED 35,4W 5814lm 4476lm (out)



Die Deckenleuchten werden in zwei Versionen mit 3 oder 6 Projektoren hergestellt.  
DALI - PUSH - 1...10V - TRIAC Dimmen auf Anfrage.

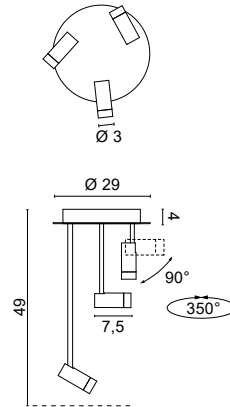

**5681.**\_\_/\_

1,70 Kg

.01	White	■
.02	Black	■
/W	4000K /25° /48° /63°	LED 17,7W 3180lm 2640lm (out)
/W	4000K /ST Satin	LED 17,7W 3180lm 2448lm (out)
/WW	3000K /25° /48° /63°	LED 17,7W 3090lm 2565lm (out)
/WW	3000K /ST Satin	LED 17,7W 3090lm 2379lm (out)
/XW	2700K /25° /48° /63°	LED 17,7W 2907lm 2412lm (out)
/XW	2700K /ST Satin	LED 17,7W 2907lm 2238lm (out)

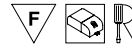

Die Deckenleuchten werden in zwei Versionen mit 3 oder 6 Projektoren hergestellt.  
DALI - PUSH - 1...10V - TRIAC Dimmen auf Anfrage.

## ZUBEHÖR

Wabenraster-Aufsatz

**0267/S**

.01	White	■
.02	Black	■



## AUSFÜHRUNGEN CODE



.01 Weiß

.02 Schwarz



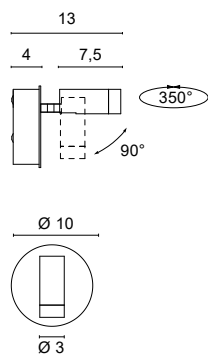

**4650.**\_\_/\_

0,30 Kg

- .01** White ■
- .02** Black ■

<b>/W</b>	4000K	/25° /48° /63°	SYS 5,9W	1060lm	880lm (out)
<b>/W</b>	4000K	/ST Satin	SYS 5,9W	1060lm	816lm (out)
<b>/WW</b>	3000K	/25° /48° /63°	SYS 5,9W	1030lm	855lm (out)
<b>/WW</b>	3000K	/ST Satin	SYS 5,9W	1030lm	793lm (out)
<b>/XW</b>	2700K	/25° /48° /63°	SYS 5,9W	969lm	804lm (out)
<b>/XW</b>	2700K	/ST Satin	SYS 5,9W	969lm	746lm (out)

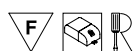

Das Modell verfügt über einen integrierten Konverter und kann sowohl an der Wand als auch an der Decke installiert werden.

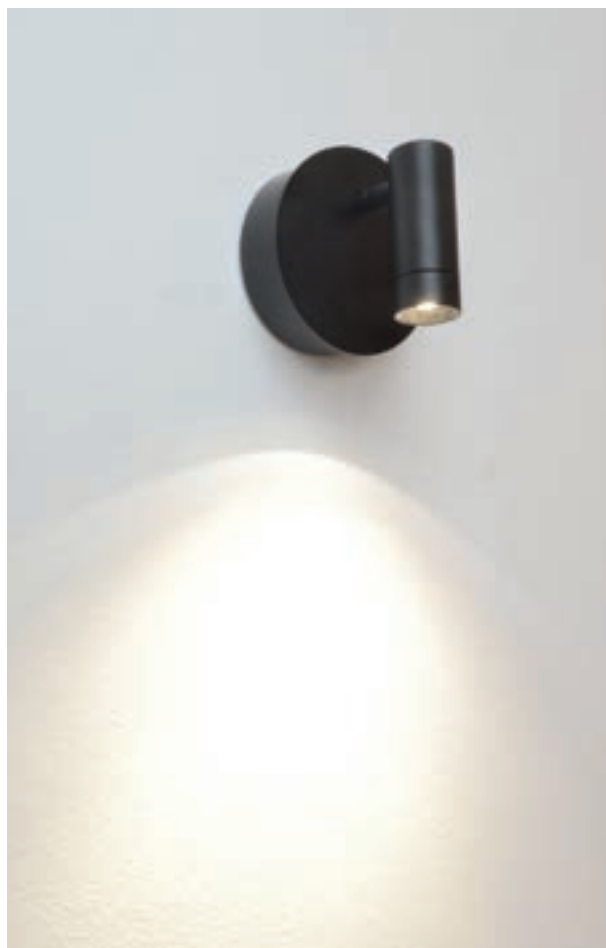

## ZUBEHÖR

Wabenraster-Aufsatz

**0267/S**

- .01** White ■
- .02** Black ■



## AUSFÜHRUNGEN CODE



**.01** Weiß

**.02** Schwarz

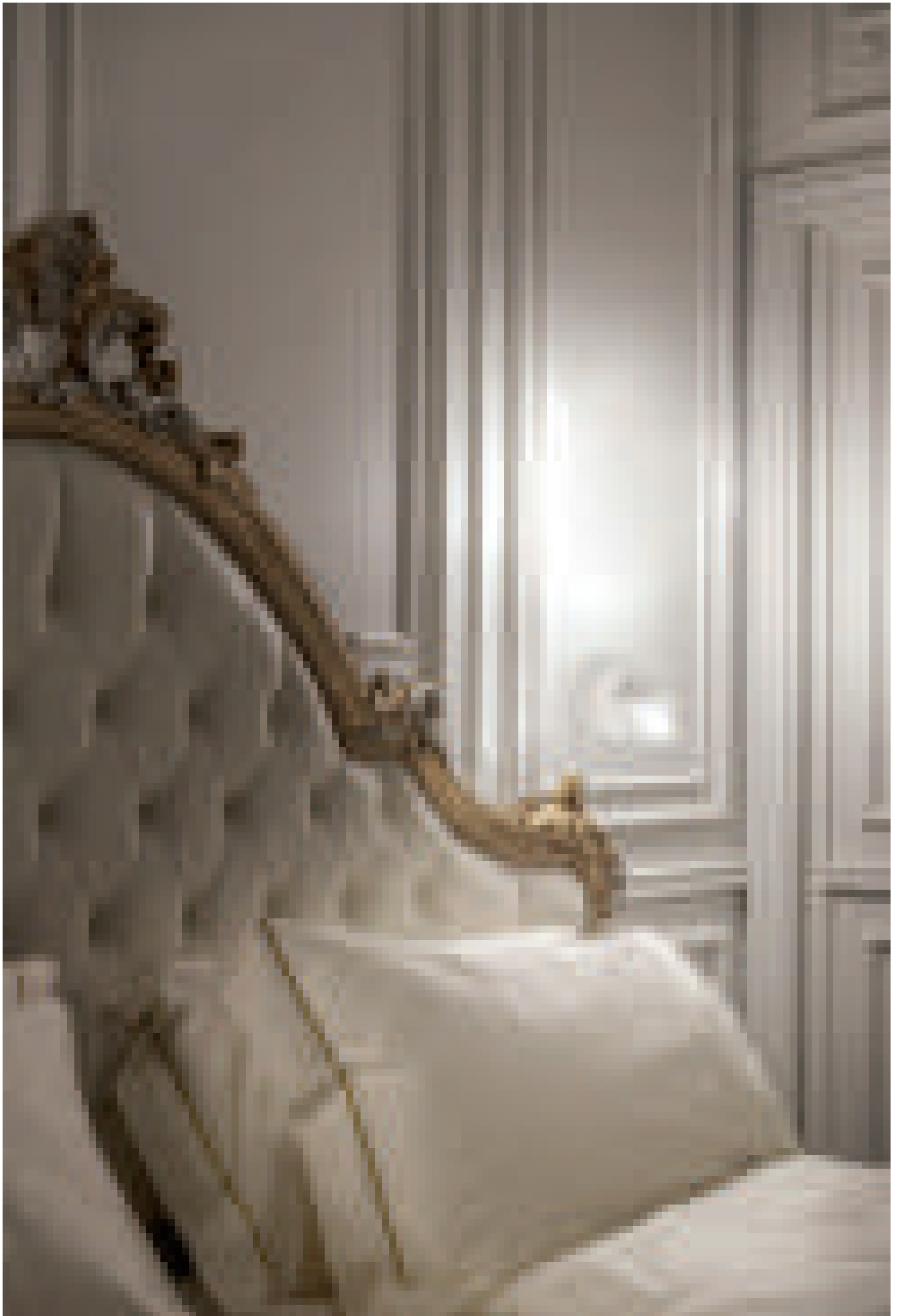

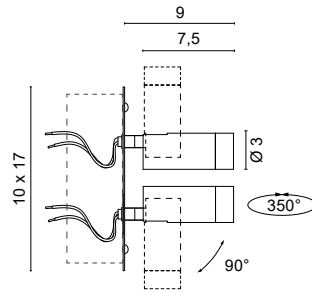
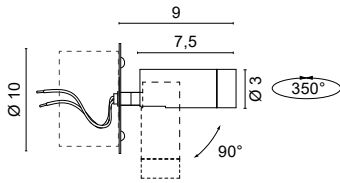

## 4640. \_\_ / \_\_

0,20 Kg

- .01 White
- .02 Black

/W	4000K	/25° /48° /63°	LED 5,9W 17V 350mA	1060lm	880lm (out)
/W	4000K	/ST Satin	LED 5,9W 17V 350mA	1060lm	816lm (out)
/WW	3000K	/25° /48° /63°	LED 5,9W 17V 350mA	1030lm	855lm (out)
/WW	3000K	/ST Satin	LED 5,9W 17V 350mA	1030lm	793lm (out)
/XW	2700K	/25° /48° /63°	LED 5,9W 17V 350mA	969lm	804lm (out)
/XW	2700K	/ST Satin	LED 5,9W 17V 350mA	969lm	746lm (out)



## 4642. \_\_ / \_\_

0,35 Kg

- .01 White
- .02 Black

/W	4000K	/25° /48° /63°	LED 11,8W 34V 350mA	2120lm	1760lm (out)
/W	4000K	/ST Satin	LED 11,8W 34V 350mA	2120lm	1632lm (out)
/WW	3000K	/25° /48° /63°	LED 11,8W 34V 350mA	2060lm	1710lm (out)
/WW	3000K	/ST Satin	LED 11,8W 34V 350mA	2060lm	1586lm (out)
/XW	2700K	/25° /48° /63°	LED 11,8W 34V 350mA	1938lm	1608lm (out)
/XW	2700K	/ST Satin	LED 11,8W 34V 350mA	1938lm	1492lm (out)



Der Konverter passt in die Wandschaltung

## KONVERTER

### ON/OFF

Cod.	0137/LED 350mA	0128 350mA
4640	1	NO
4642	NO	1

Nur seelsische Verbindung

## ZUBEHÖR

Wabenraster-Aufsatz  
**0267/S**

- .01 White
- .02 Black



Wallbox  
**0279**



Wallbox  
**0280**



## AUSFÜHRUNGEN CODE



.01 Weiß

.02 Schwarz



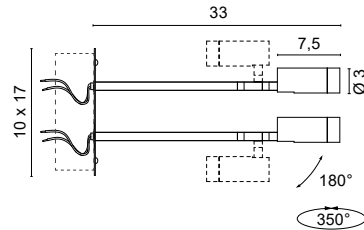
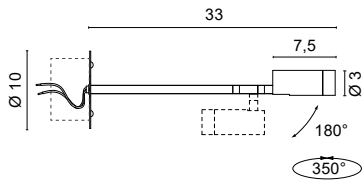

## 4641. \_ / \_

0,20 Kg

.01	White	■
.02	Black	■

/W	4000K	/25° /48° /63°	LED 5,9W 17V 350mA	1060lm	880lm (out)
/W	4000K	/ST Satin	LED 5,9W 17V 350mA	1060lm	816lm (out)
/WW	3000K	/25° /48° /63°	LED 5,9W 17V 350mA	1030lm	855lm (out)
/WW	3000K	/ST Satin	LED 5,9W 17V 350mA	1030lm	793lm (out)
/XW	2700K	/25° /48° /63°	LED 5,9W 17V 350mA	969lm	804lm (out)
/XW	2700K	/ST Satin	LED 5,9W 17V 350mA	969lm	746lm (out)

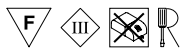

## 4643. \_ / \_

0,42 Kg

.01	White	■
.02	Black	■

/W	4000K	/25° /48° /63°	LED 11,8W 34V 350mA	2120lm	1760lm (out)
/W	4000K	/ST Satin	LED 11,8W 34V 350mA	2120lm	1632lm (out)
/WW	3000K	/25° /48° /63°	LED 11,8W 34V 350mA	2060lm	1710lm (out)
/WW	3000K	/ST Satin	LED 11,8W 34V 350mA	2060lm	1586lm (out)
/XW	2700K	/25° /48° /63°	LED 11,8W 34V 350mA	1938lm	1608lm (out)
/XW	2700K	/ST Satin	LED 11,8W 34V 350mA	1938lm	1492lm (out)



Der Konverter passt in die Wandschaltung

## KONVERTER

### ON/OFF

Cod.	0137/LED 350mA	0128 350mA
4641	1	NO
4643	NO	1

Nur seelische Verbindung

## ZUBEHÖR

### Wabenraster-Aufsatz 0267/S

.01	White	■
.02	Black	■



### Wallbox 0279



### Wallbox 0280



## AUSFÜHRUNGEN CODE



.01 Weiß

.02 Schwarz





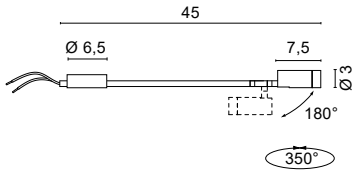

4655. \_ \_ / \_ \_

0,30 Kg

.01	White	
.02	Black	
.25	Satin gold	

/W	4000K	/25° /48° /63°	LED 5,9W 17V 350mA	1060lm	880lm (out)
/W	4000K	/ST Satin	LED 5,9W 17V 350mA	1060lm	816lm (out)
/WW	3000K	/25° /48° /63°	LED 5,9W 17V 350mA	1030lm	855lm (out)
/WW	3000K	/ST Satin	LED 5,9W 17V 350mA	1030lm	793lm (out)
/XW	2700K	/25° /48° /63°	LED 5,9W 17V 350mA	969lm	804lm (out)
/XW	2700K	/ST Satin	LED 5,9W 17V 350mA	969lm	746lm (out)



Nur serielle Verbindung

## KONVERTER

### ON/OFF

Cod.	0125 350mA	0128 350mA
4655	1	1-2

### DIMMABLE

0129 PUSH - 1...10V	0141/DIM PUSH - 1...10V	0145/DIM PUSH - 1...10V	0733/DIM PHASE CUT
0129/DALI DIM DALI	0141/DALI DIM DALI	0145/DALI DIM DALI	0733/DIM PHASE CUT
1-2	1-2	1-3	1

### CASAMBI

#### 0145/CASA

1-3

### LED EMERGENCY UNIT

#### 0115/EM INVERTER + BATTERY + LED INDICATOR

1

## ZUBEHÖR

Wabenraster-Aufsatz

0267/S

.01	White	
.02	Black	





## AUSFÜHRUNGEN CODE



**.01** Weiß

**.02** Schwarz

**.25** Gold satiniert

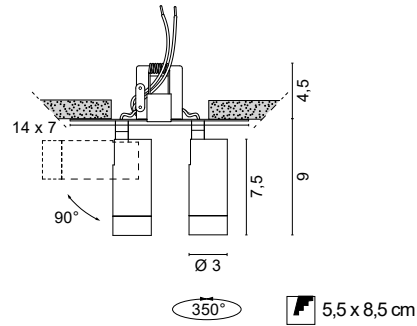
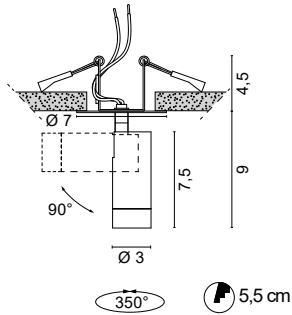

## 6750. \_\_ / \_\_

0,23 Kg

<b>.01</b>	White	
<b>.02</b>	Black	
<b>.25</b>	Satin gold	

<b>/W</b>	4000K	/25° /48° /63°	LED 5,9W 17V 350mA	1060lm	880lm (out)
<b>/W</b>	4000K	/ST Satin	LED 5,9W 17V 350mA	1060lm	816lm (out)
<b>/WW</b>	3000K	/25° /48° /63°	LED 5,9W 17V 350mA	1030lm	855lm (out)
<b>/WW</b>	3000K	/ST Satin	LED 5,9W 17V 350mA	1030lm	793lm (out)
<b>/XW</b>	2700K	/25° /48° /63°	LED 5,9W 17V 350mA	969lm	804lm (out)
<b>/XW</b>	2700K	/ST Satin	LED 5,9W 17V 350mA	969lm	746lm (out)

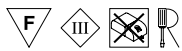

## 6751. \_\_ / \_\_

0,40 Kg

<b>.01</b>	White	
<b>.02</b>	Black	
<b>.25</b>	Satin gold	

<b>/W</b>	4000K	/25° /48° /63°	LED 11,8W 34V 350mA	2120lm	1760lm (out)
<b>/W</b>	4000K	/ST Satin	LED 11,8W 34V 350mA	2120lm	1632lm (out)
<b>/WW</b>	3000K	/25° /48° /63°	LED 11,8W 34V 350mA	2060lm	1710lm (out)
<b>/WW</b>	3000K	/ST Satin	LED 11,8W 34V 350mA	2060lm	1586lm (out)
<b>/XW</b>	2700K	/25° /48° /63°	LED 11,8W 34V 350mA	1938lm	1608lm (out)
<b>/XW</b>	2700K	/ST Satin	LED 11,8W 34V 350mA	1938lm	1492lm (out)



Irís vertieft, auch mit Doppelprojektor erhältlich, muss auf Gipskartonflächen installiert werden. Auch als Version in gebürstetem Gold mit galvanischer Oberfläche erhältlich. Der Konverter muss separat bestellt werden.

## KONVERTER

### ON/OFF

Cod.	0125 350mA	0128 350mA
<b>6750</b>	1	1-2
<b>6751</b>	NO	1

### DIMMABLE

0129 PUSH - 1...10V	0141/DIM PUSH - 1...10V	0145/DIM PUSH - 1...10V	
<b>0129/DALI</b> DIM DALI	<b>0141/DALI</b> DIM DALI	<b>0145/DALI</b> DIM DALI	<b>0733/DIM</b> PHASE CUT
<b>6750</b> 1-2	1-2	1-3	1
<b>6751</b> 1	1	1	NO

### CASAMBI

#### 0145/CASA

<b>6750</b>	1-3
<b>6751</b>	1

### LED EMERGENCY UNIT

#### 0115/EM INVERTER + BATTERY + LED INDICATOR

<b>6750</b>	1
<b>6751</b>	1

Nur serielle Verbindung

## ZUBEHÖR

Wabenraster-Aufsatz

### 0267/S

<b>.01</b>	White	
<b>.02</b>	Black	





#### AUSFÜHRUNGEN CODE



.01 Weiß

.02 Schwarz

.25 Gold satiniert

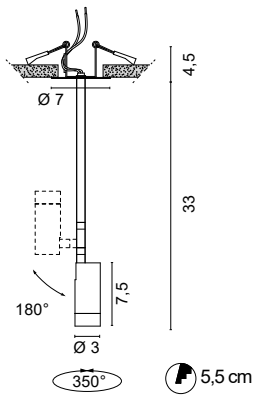

**6753.**\_\_/\_

0,23 Kg

- .01 White
- .02 Black

<b>/W</b>	4000K	/25° /48° /63°	LED 5,9W 17V 350mA	1060lm	880lm (out)
<b>/W</b>	4000K	/ST Satin	LED 5,9W 17V 350mA	1060lm	816lm (out)
<b>/WW</b>	3000K	/25° /48° /63°	LED 5,9W 17V 350mA	1030lm	855lm (out)
<b>/WW</b>	3000K	/ST Satin	LED 5,9W 17V 350mA	1030lm	793lm (out)
<b>/XW</b>	2700K	/25° /48° /63°	LED 5,9W 17V 350mA	969lm	804lm (out)
<b>/XW</b>	2700K	/ST Satin	LED 5,9W 17V 350mA	969lm	746lm (out)



Die Iris-Einbauleuchte, die auch mit Doppelprojektor erhältlich ist, muss auf Gipskartonflächen installiert werden.  
Der Konverter muss separat bestellt werden.

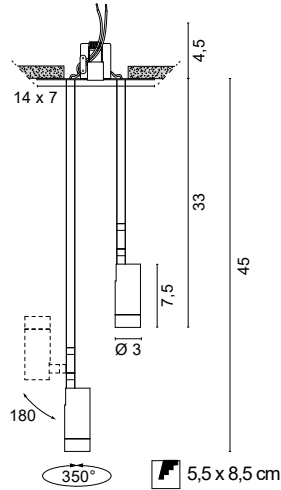

**6752.**\_\_/\_

0,47 Kg

- .01 White
- .02 Black

<b>/W</b>	4000K	/25° /48° /63°	LED 11,8W 34V 350mA	2120lm	1760lm (out)
<b>/W</b>	4000K	/ST Satin	LED 11,8W 34V 350mA	2120lm	1632lm (out)
<b>/WW</b>	3000K	/25° /48° /63°	LED 11,8W 34V 350mA	2060lm	1710lm (out)
<b>/WW</b>	3000K	/ST Satin	LED 11,8W 34V 350mA	2060lm	1586lm (out)
<b>/XW</b>	2700K	/25° /48° /63°	LED 11,8W 34V 350mA	1938lm	1608lm (out)
<b>/XW</b>	2700K	/ST Satin	LED 11,8W 34V 350mA	1938lm	1492lm (out)



## KONVERTER

### ON/OFF

Cod.	0125 350mA	0128 350mA
<b>6752</b>	NO	1
<b>6753</b>	1	1-2

### DIMMABLE

0129 PUSH - 1...10V	0141/DIM PUSH - 1...10V	0145/DIM PUSH - 1...10V	
<b>0129/DALI</b> DIM DALI	<b>0141/DALI</b> DIM DALI	<b>0145/DALI</b> DIM DALI	<b>0733/DIM</b> PHASE CUT
<b>6752</b> 1	1	1	NO
<b>6753</b> 1-2	1-2	1-3	1

### CASAMBI

#### 0145/CASA

<b>6752</b>	1
<b>6753</b>	1-3

### LED EMERGENCY UNIT

#### 0115/EM INVERTER + BATTERY + LED INDICATOR

<b>6752</b>	1
<b>6753</b>	1

Nur serielle Verbindung

## ZUBEHÖR

Wabenraster-Aufsatz

### 0267/S

- .01 White
- .02 Black





## AUSFÜHRUNGEN CODE



.01 Weiß

.02 Schwarz

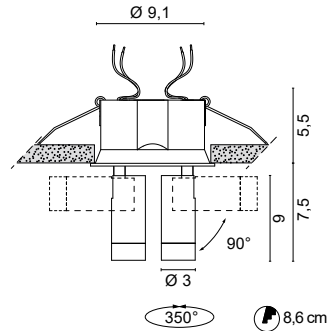
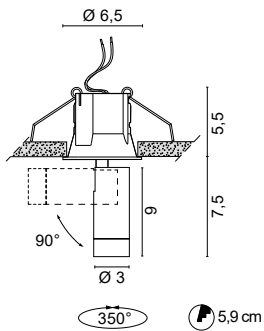

## 6755. \_\_ / \_\_

0,20 Kg

.01	White	■
.02	Black	■
<b>/W</b>	4000K /25° /48° /63°	LED 5,9W 17V 350mA 1060lm 880lm (out)
<b>/W</b>	4000K /ST Satin	LED 5,9W 17V 350mA 1060lm 816lm (out)
<b>/WW</b>	3000K /25° /48° /63°	LED 5,9W 17V 350mA 1030lm 855lm (out)
<b>/WW</b>	3000K /ST Satin	LED 5,9W 17V 350mA 1030lm 793lm (out)
<b>/XW</b>	2700K /25° /48° /63°	LED 5,9W 17V 350mA 969lm 804lm (out)
<b>/XW</b>	2700K /ST Satin	LED 5,9W 17V 350mA 969lm 746lm (out)



Iris Einbau, auch mit Doppelprojektor erhältlich, muss auf Gipskartonflächen installiert werden.  
Auch als Version in gebürstetem Gold mit galvanischer Oberfläche erhältlich.  
Der Konverter muss separat bestellt werden.

## 6756. \_\_ / \_\_

0,45 Kg

.01	White	■
.02	Black	■
<b>/W</b>	4000K /25° /48° /63°	LED 11,8W 34V 350mA 2120lm 1760lm (out)
<b>/W</b>	4000K /ST Satin	LED 11,8W 34V 350mA 2120lm 1632lm (out)
<b>/WW</b>	3000K /25° /48° /63°	LED 11,8W 34V 350mA 2060lm 1710lm (out)
<b>/WW</b>	3000K /ST Satin	LED 11,8W 34V 350mA 2060lm 1586lm (out)
<b>/XW</b>	2700K /25° /48° /63°	LED 11,8W 34V 350mA 1938lm 1608lm (out)
<b>/XW</b>	2700K /ST Satin	LED 11,8W 34V 350mA 1938lm 1492lm (out)



## KONVERTER

### ON/OFF

Cod.	0125 350mA	0128 350mA
<b>6755</b>	1	1-2
<b>6756</b>	NO	1

### DIMMABLE

0129	0141/DIM	0145/DIM	
PUSH - 1...10V	PUSH - 1...10V	PUSH - 1...10V	
0129/DALI	0141/DALI	0145/DALI	0733/DIM
DIM DALI	DIM DALI	DIM DALI	PHASE CUT
<b>6755</b>	1-2	1-3	1
<b>6756</b>	1	1	NO

### CASAMBI

#### 0145/CASA

<b>6755</b>	1-3
<b>6756</b>	1

### LED EMERGENCY UNIT

#### 0115/EM INVERTER + BATTERY + LED INDICATOR

<b>6755</b>	1
<b>6756</b>	1

Nur serielle Verbindung

## ZUBEHÖR

Wabenraster-Aufsatz

### 0267/S

.01	White	■
.02	Black	■







Optic 25°



Optic 48°

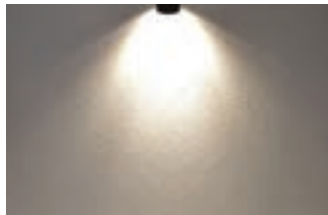

Optic 63°

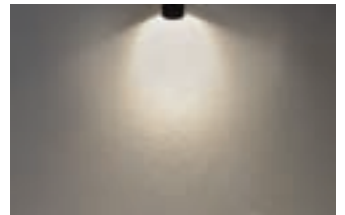

Optic satin

## AUSFÜHRUNGEN CODE

---



**.01** Weiß

**.02** Schwarz



INDOOR

# FARO

Design LUX Studio





# FARO



Tisch und Stehleuchten-Serie aus Aluminiumstruktur, gekennzeichnet durch kleine verstellbare Projektoren, um die Qualität des Akzentlichts optimal zu nutzen.

Die nach hinten gerichtete Positionierung der Quelle und deren Dimmung garantieren perfekten Sehkomfort.



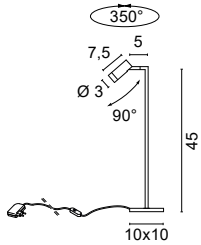

**2525.**\_\_/\_/\_\_\_ 0,95 Kg

- .01 White
- .02 Black

/W	4000K	LED 5,9W	1060lm
/WW	3000K	LED 5,9W	1030lm
/XW	2700K	LED 5,9W	969lm



Mit DIMMER am schwarzen Kabel

## ZUBEHÖR

Wabenraster-Aufsatz

### 0267/S

- .01 White
- .02 Black

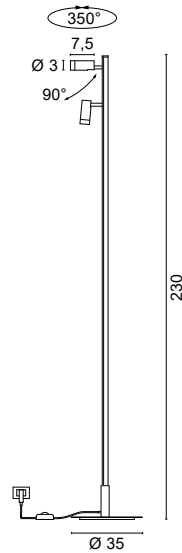

**3536.**\_\_/\_/\_\_\_ 5,40 Kg

- .01 White
- .02 Black

/W	4000K	LED 11,8W	2128lm
/WW	3000K	LED 11,8W	2060lm
/XW	2700K	LED 11,8W	1938lm

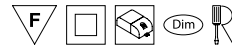

Mit DIMMER am schwarzen Kabel



## AUSFÜHRUNGEN CODE



.01 Weiß

.02 Schwarz







**INDOOR**

# **MATITA**

Design Mati





Die Matita-Kollektion zeichnet sich durch das schlanke Aluminiumprofil und die hocheffiziente LED-Mikroschaltung aus. Die Designforschung, die von diesen beiden Elementen ausging, konzentrierte sich auf die Miniaturisierung und Aufhellung aller anderen Komponenten mit dem Ziel, das Wesentliche zu belassen, um nur Lichtlinien im Raum wahrzunehmen. In diese Richtung ging die Wahl der Gelenke, die eine freie Bewegung der Profile ermöglichen, und des transparenten Nylonseils, das die Aufhängungen im Leeren schweben lässt.



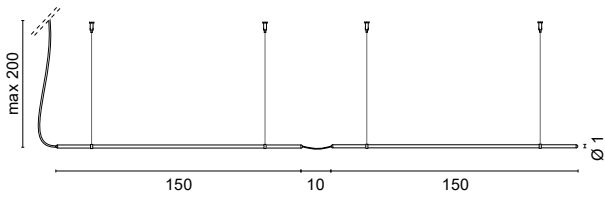

**1674.**\_\_/\_ \_\_ 2x150cm 0,50 Kg

**.02** Black

**/W** 4000K LED 37,5W 4440lm

**/WW** 3000K LED 37,5W 4050lm

**/XW** 2700K LED 37,5W 3600lm



Das Befestigungsset für die Aufhängung ist im Lieferumfang der Leuchte enthalten.

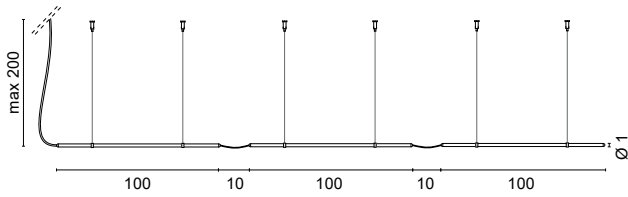

**1675.**\_\_/\_ \_\_ 3x100cm 0,60 Kg

**.02** Black

**/W** 4000K LED 37,5W 4440lm

**/WW** 3000K LED 37,5W 4050lm

**/XW** 2700K LED 37,5W 3600lm



Das Befestigungsset für die Aufhängung ist im Lieferumfang der Leuchte enthalten.

## AUSFÜHRUNGEN CODE

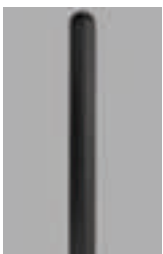

**.02** Schwarz



Deckenrosetten mit Konverter für Aufhängesysteme siehe Seite 174

# DECKENROSETTEN SYSTEM 24V

MATITA

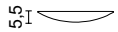
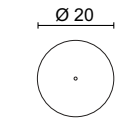
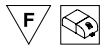

Deckenrosette mit **60W** Konverter

50/60Hz 220-230V

**0990/60.**\_\_/\_/\_\_\_

0,70Kg

.01	White	
.02	Black	
.85	Painted silver finishing	
.86	Painted gold finishing	
.87	Painted copper finishing	
.88	Painted bronze finishing	

/P	DIMMER		MAX 60W
/V	DIMMER		MAX 60W
/D	DIMMER		MAX 60W

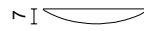
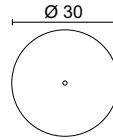

Deckenrosette mit **100W** Konverter

50/60Hz 220-230V

**0990/100.**\_\_/\_/\_\_\_

1,30Kg

.01	White	
.02	Black	
.85	Painted silver finishing	
.86	Painted gold finishing	
.87	Painted copper finishing	
.88	Painted bronze finishing	

/P	DIMMER		MAX 100W
/V	DIMMER		MAX 100W
/D	DIMMER		MAX 100W

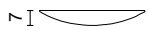
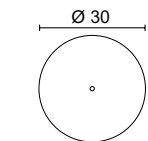

Deckenrosette mit **150W** Konverter

50/60Hz 220-230V

**0990/150.**\_\_/\_/\_\_\_

1,30Kg

.01	White	
.02	Black	
.85	Painted silver finishing	
.86	Painted gold finishing	
.87	Painted copper finishing	
.88	Painted bronze finishing	

/P	DIMMER		MAX 150W
/V	DIMMER		MAX 150W
/D	DIMMER		MAX 150W

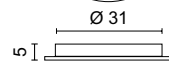
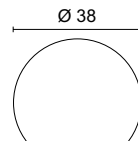

Deckenrosette mit **200W** Konverter

50/60Hz 220-230V

**0990/200.**\_\_/\_/\_\_\_

2,00 kg

.01	White	
.02	Black	
.85	Painted silver finishing	
.86	Painted gold finishing	
.87	Painted copper finishing	
.88	Painted bronze finishing	

/P	DIMMER		MAX 2x100W
/V	DIMMER		MAX 2x100W
/D	DIMMER		MAX 2x100W

## BEISPIELE FÜR MEHRFACHINSTALLATIONEN

Die Wahl der Deckenrosette hängt vom Gesamtstromverbrauch ab.

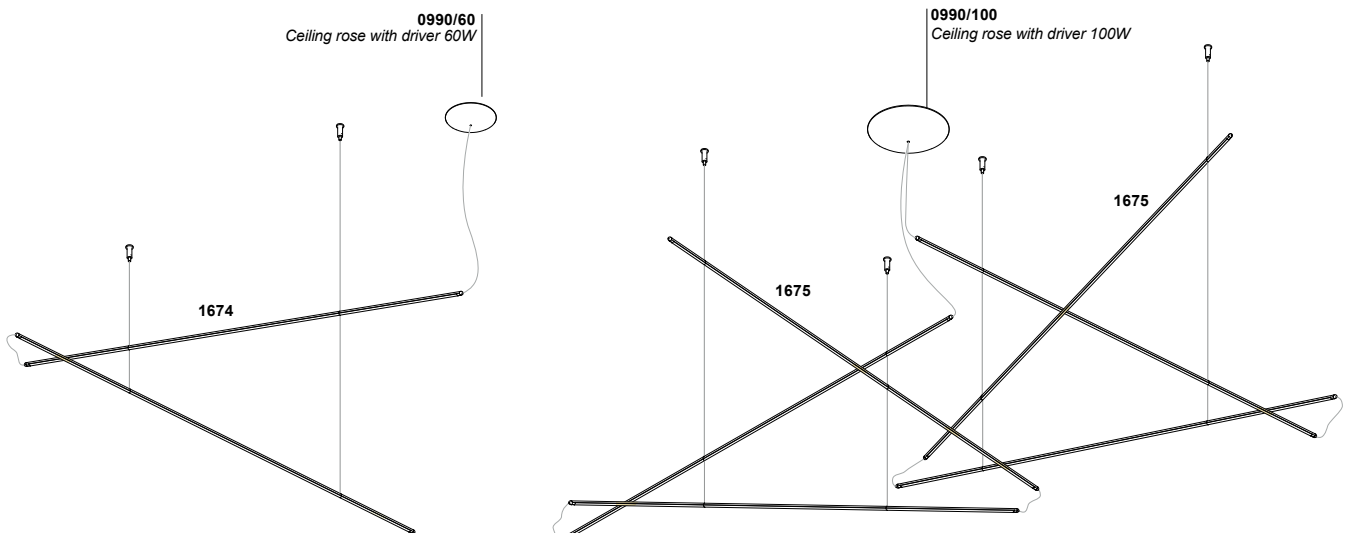



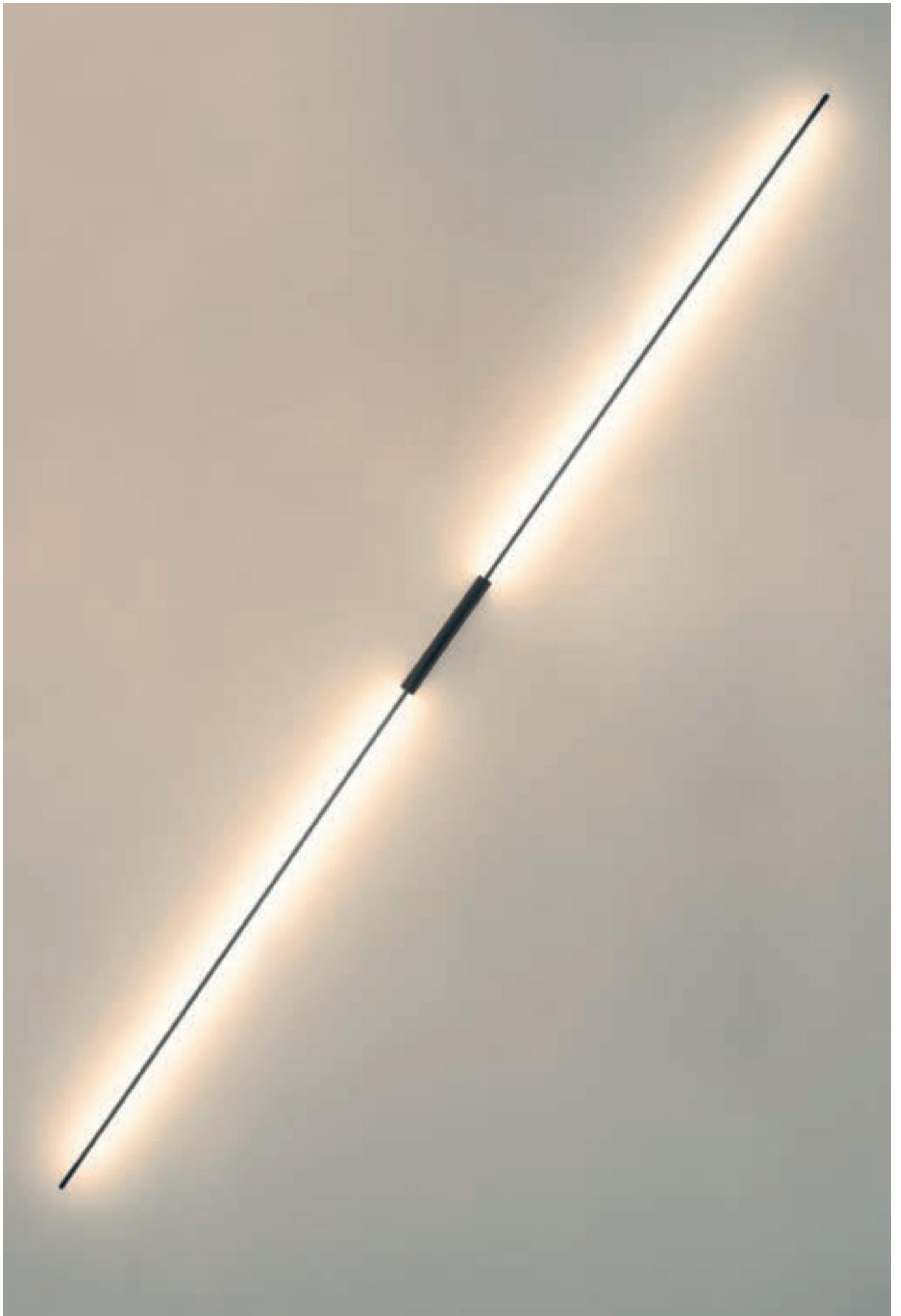



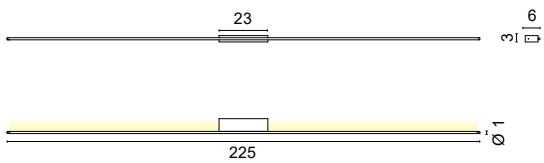

**4634.** \_ \_ / \_ \_ 0,80 Kg

**.02** Black ■

**/W** 4000K LED 27,5W 3256lm

**/WW** 3000K LED 27,5W 2970lm

**/XW** 2700K LED 27,5W 2640lm



Nicht einstellbar - TRIAC-Dimmen auf Anfrage

**AUSFÜHRUNGEN CODE**



**.02** Schwarz





**INDOOR**

# **DIESIS**

Design LUX Studio





## DIESIS



Decken- und Wandleuchten mit diffusem und indirektem Licht - ausgeführt mit einem Aluminiumgehäuse und opalem Polycarbonat-Diffusor. Der hohe Lichtstrom macht DIESIS ideal für die Allgemeinbeleuchtung eines Raumes mit nur einem Lichtpunkt.



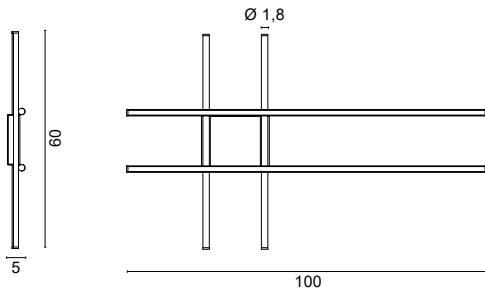

**4636.**\_\_\_/\_\_\_ 1,50 Kg

- .01** White ■
- .02** Black ■
- .35** Painted Sand finishing ■

<b>/W</b>	4000K	LED 50,4W	6328lm
<b>/WW</b>	3000K	LED 50,4W	5656lm
<b>/XW</b>	3000K	LED 50,4W	5292lm

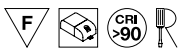

Dimmbar auf Anfrage

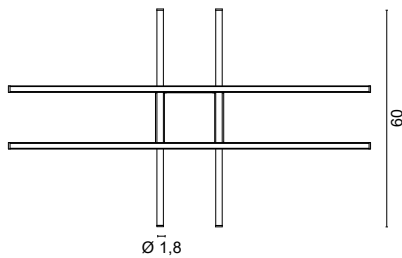
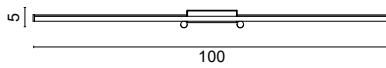
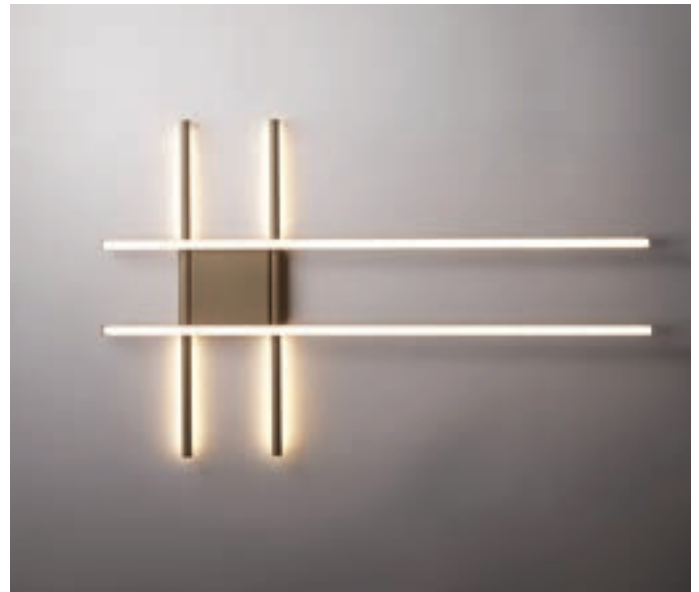

**5691.**\_\_\_/\_\_\_ 1,50 Kg

- .01** White ■
- .02** Black ■
- .35** Painted Sand finishing ■

<b>/W</b>	4000K	LED 50,4W	6328lm
<b>/WW</b>	3000K	LED 50,4W	5656lm
<b>/XW</b>	3000K	LED 50,4W	5292lm

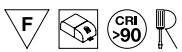

Dimmbar auf Anfrage

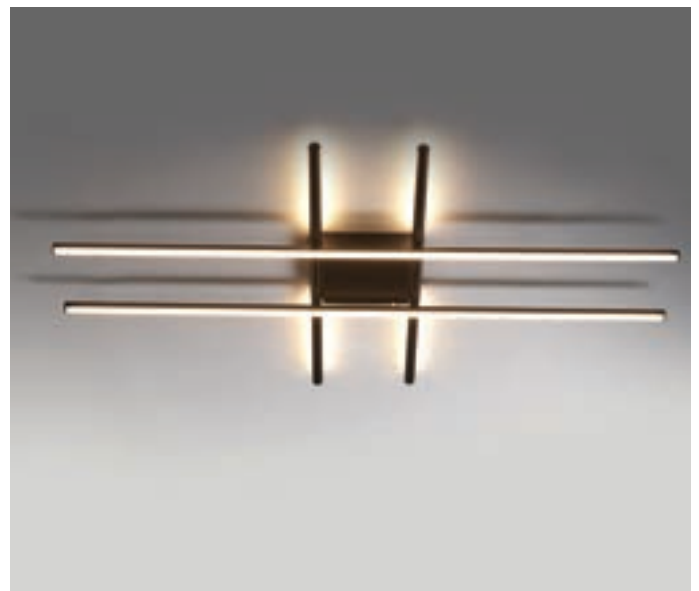

## AUSFÜHRUNGEN CODE

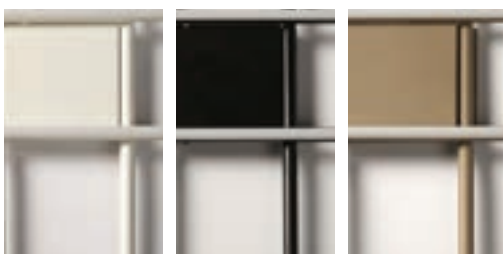

- .01** Weiß
- .02** Schwarz
- .35** Sand lackiert







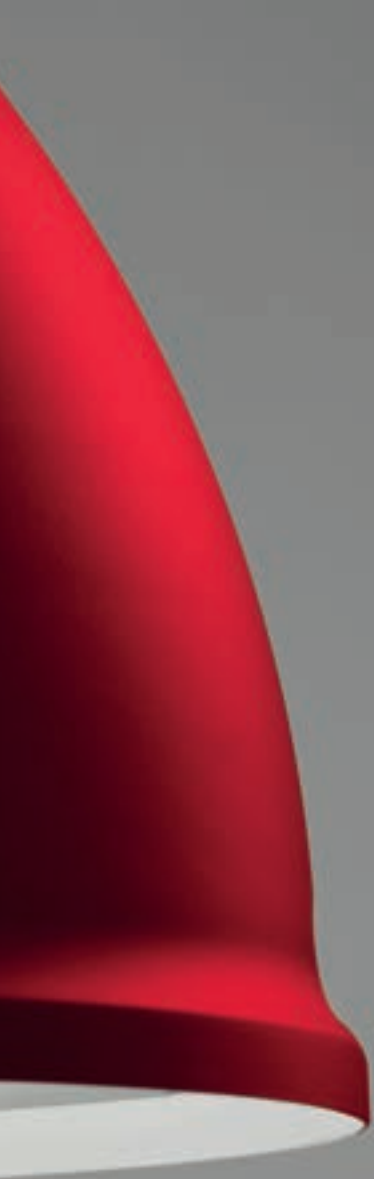

**INDOOR**

# **PAVILLON**

Design ABS Studio









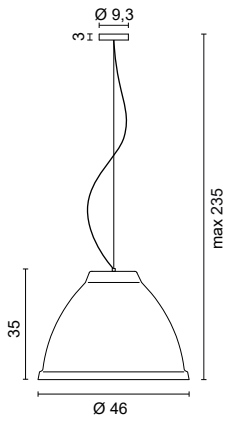

Große Pendelleuchte aus gedrehtem Aluminium. Erhältlich in verschiedenen Ausführungen. Die Lampenfassung mit E27-Fassung ermöglicht die Verwendung aller neuen LED-Quellen und bietet die Möglichkeit, das gewünschte Licht auszuwählen. Seine schlichte Linie, die an die klassischen Modelle der Beleuchtung von Lagerhallen und großen Industriehallen erinnert, wird heute sowohl in öffentlichen als auch in privaten modernen Umgebungen verwendet.





**1558.**\_\_/\_ \_\_ 1,10 Kg

<b>.01</b>	White	
<b>.02.01</b>	Out black/In white	
<b>.05.01</b>	Out red/In white	
<b>.35</b>	Painted Sand finishing	
<b>/W</b>	4000K E27 LED 15W	2200lm
<b>/XW</b>	2700K E27 LED 15W	2200lm



## ZUBEHÖR

Komponente Abhängung Ø 1 cm H 3,5cm

### 0532

<b>.31</b>	Cromed	
------------	--------	---



## AUSFÜHRUNGEN CODE

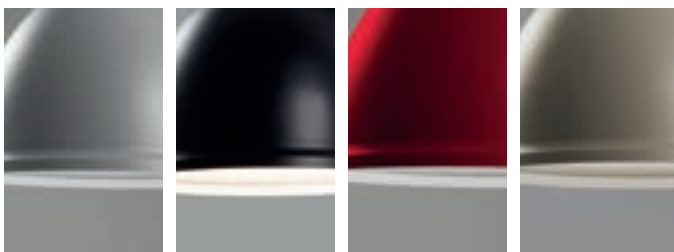

**.01** Weiß

**.02.01**  
Außen Schwarz  
Innen Weiß

**.05.01**  
Außen Rot  
Innen Weiß

**.35** Sand lackiert







INDOOR

# GIOVE

Design ABS Studio







Große Hängeleuchte für direktes Licht mit gedrehter Aluminiumstruktur und Lampenfassung mit E27-Fassung. Erhältlich in drei verschiedenen Ausführungen, einige davon sehr einzigartig, wie z.B. Blattgold.

Die Halbkugelform und die verschiedenen E27-Leuchtmittel erzeugen ein angenehmes Umgebungslicht, das sich für jede Art von Umgebung, ob öffentlich oder privat, und jeden Stil, ob klassisch oder modern, eignet.



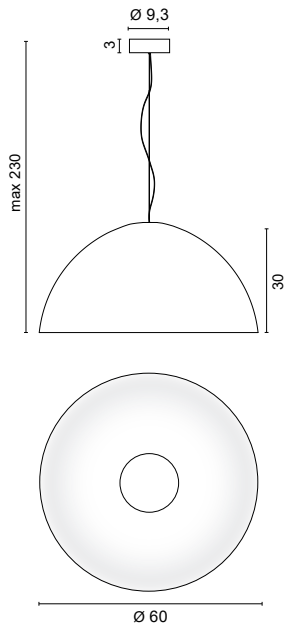

**1599.**\_\_ 3,50 Kg

<b>.01</b>	White	■
<b>.02</b>	Black	■
<b>.02.01</b>	Out black / In white	■
<b>.02.29</b>	Out black / gold leaf	■

E27 15W LED 2200lm



## ZUBEHÖR

Komponente Abhängung Ø 1 cm H 3,5cm

**0532**

<b>.31</b>	Cromed	■
------------	--------	---

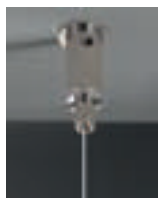

## AUSFÜHRUNGEN CODE

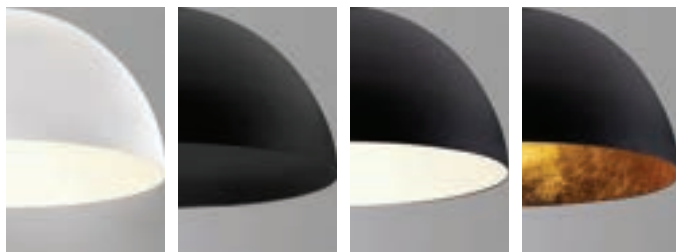

**.01** Weiß

**.02** Schwarz

**.02.01**  
Außen Schwarz  
Innen Weiß

**.02.29**  
Außen Schwarz  
Innen Blattgold





LIBRERIA

INDOOR

# UNIDEA

Design ABS STUDIO





Der Korpus der Unidea-Familie ist aus rohem Eisen gefertigt und mit LED-Leuchtmittel aus mundgeblasenem Glas verziert. Die Kollektion Unidea besteht aus Hänge- und Tischleuchten.

Die Form und das Retrò-Design der Glühbirnen verleihen Unidea jene emotionale Eleganz, die das Beleuchtungsprojekt einzigartig macht.

Die Deckenrosetten und das Zubehör werden je nach Art der gewählten Komposition separat bestellt.



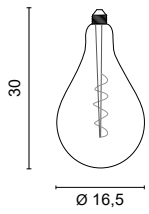

**1600.**\_\_/\_/\_\_\_ 0,20 Kg

.70	Retrò	<input type="checkbox"/>
.71	Fumè	<input type="checkbox"/>
.70	2000K E27 LED 4,5W	300lm
.71	1800K E27 LED 5W	110lm

Dim

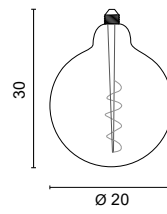

**1601.**\_\_/\_/\_\_\_ 0,20 Kg

.70	Retrò	<input type="checkbox"/>
.71	Fumè	<input type="checkbox"/>
.70	2000K E27 LED 4,5W	250lm
.71	1800K E27 LED 5W	110lm

Dim

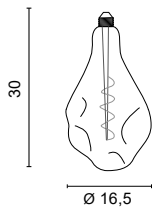

**1602.**\_\_/\_/\_\_\_ 0,20 Kg

.70	Retrò	<input type="checkbox"/>
.71	Fumè	<input type="checkbox"/>
.70	2000K E27 LED 5W	270lm
.71	1800K E27 LED 5W	110lm

Dim

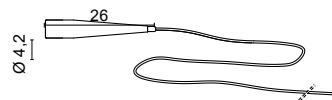

**0977/3** 300 cm  
**0977/5** 500 cm

**0977/3** Lampenfassung E27 mit Kabel 3 mt

.71	Fumè	<input type="checkbox"/>
-----	------	--------------------------

**0977/5** Lampenfassung E27 mit Kabel 5 mt

.71	Fumè	<input type="checkbox"/>
-----	------	--------------------------



## AUSFÜHRUNGEN CODE

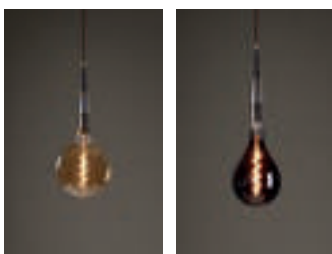

.70 Retrò

.71 Fumè





Deckenrosetten mit Konverter für Aufhängesysteme siehe Seite 204



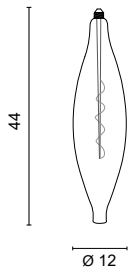

**1603.** \_ / \_ 0,50 Kg

**.70** Retrò

**.70** 2000K E27 LED 11W 1000lm

Dim

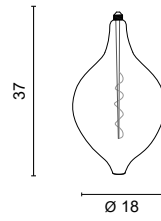

**1604.** \_ / \_ 0,50 Kg

**.70** Retrò

**.70** 2000K E27 LED 11W 1000lm

Dim

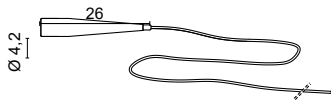

**0977/3** 300 cm  
**0977/5** 500 cm

**0977/3** Lampenfassung E27 mit Kabel 3 mt

**.71** Fumè

**0977/5** Lampenfassung E27 mit Kabel 5 mt

**.71** Fumè



## AUSFÜHRUNGEN CODE

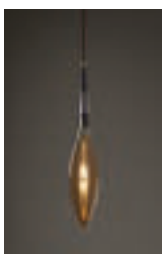

**.70** Retrò

# DECKENROSETTEN FÜR UNIDEA-KOMPOSITIONEN

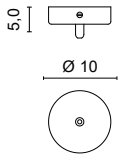

Deckenrosette für 1 Unidea  
**IN** 50/60Hz 220-240V

**0976/1**

1,00 Kg

**.71** Fumè

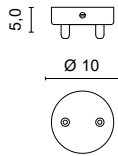

Deckenrosette für 2 Unidea  
**IN** 50/60Hz 220-240V

**0976/2**

1,00 Kg

**.71** Fumè

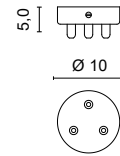

Deckenrosette für 3 Unidea  
**IN** 50/60Hz 220-240V

**0976/3**

1,00 Kg

**.71** Fumè

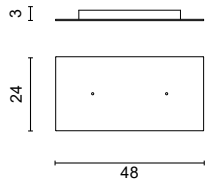

Deckenrosette für 2 Unidea  
**IN** 50/60Hz 220-240V

**0978/2**

2,00 Kg

**.02** Black

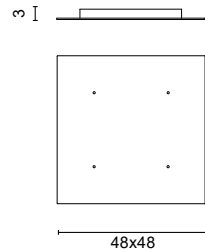

Deckenrosette für 4 Unidea  
**IN** 50/60Hz 220-240V

**0978/4**

3,80 Kg

**.02** Black

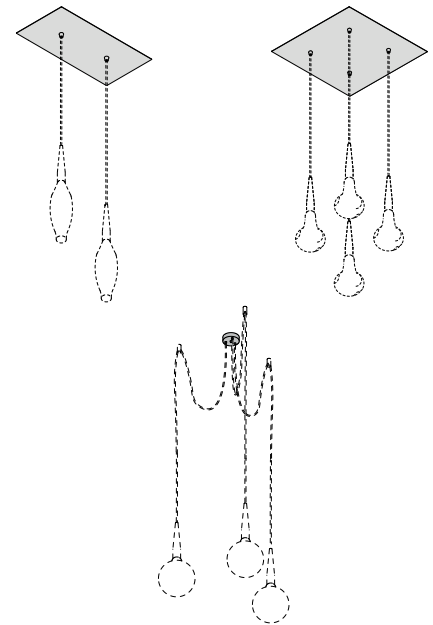

## ZUBEHÖR

1 Verbindungselement aus satiniertem Messing für die Deckenbefestigung

**0975/1**

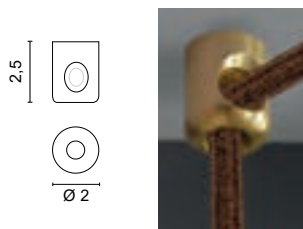



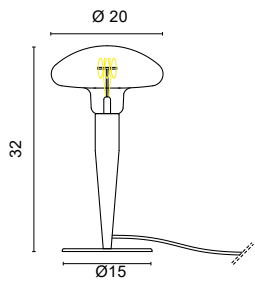

**2512.**\_\_/\_/\_\_\_ 1,00 Kg

**.70** Retrò

**.70** 2000K E27 LED 5W 250lm



Modell mit ON - OFF Schalter



## AUSFÜHRUNGEN CODE

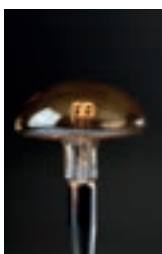

**.70** Retrò







INDOOR

# TRE&SESSANTA

Design U.T. EGOLUCE



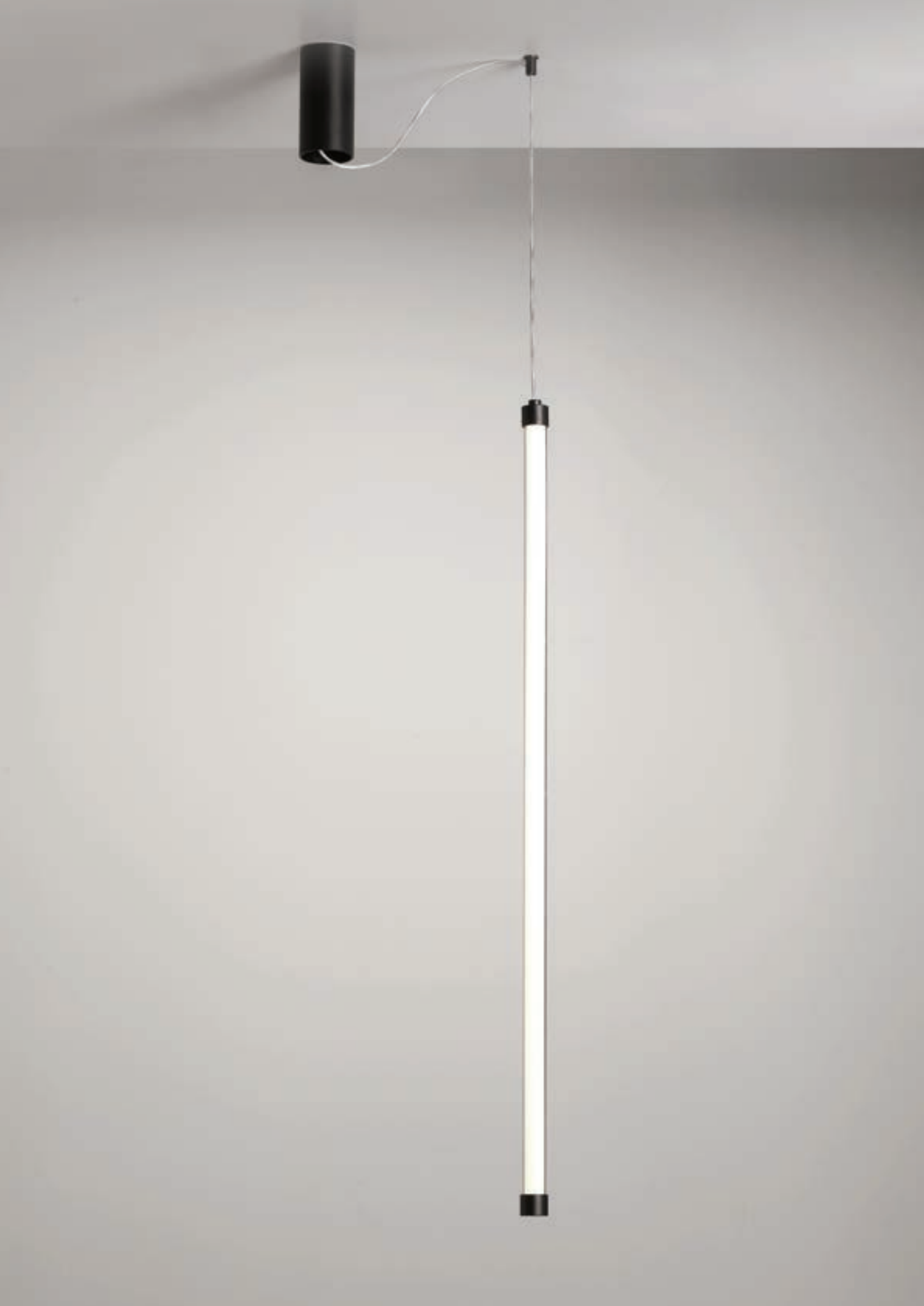

Hängeleuchte mit diffusem Licht, bestehend aus einem transparentem Methacrylatkörper mit eloxierten Aluminiumkappen. Die Lichtquelle ist ein doppelter, gegenüberliegender LED-Schaltkreis, umhüllt von einem extrudierten weißen Silikon.

Die Leuchte zeichnet sich durch einen 360°-Lichtaustritt aus, der über die gesamte Länge frei von Schatten und dunklen Stellen ist. Die Deckenrosetten mit dem Konverter werden je nach Verwendung der Beleuchtungselemente separat bestellt.



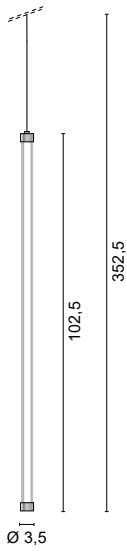

**1662.**\_\_/\_/\_\_\_ 0,75 Kg

- .01** White ■
- .02** Black ■
- .23** Satin aluminium ■

**/WW** 3000K LED 24V 20W 1920lm



Deckenrosetten mit Treibern sind separat zu bestellen



1 Verdrängungskomponente enthalten

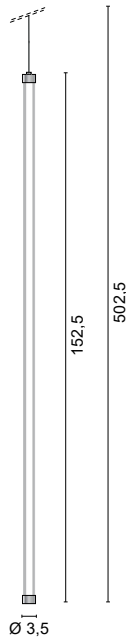

**1663.**\_\_/\_/\_\_\_ 1,10 Kg

- .01** White ■
- .02** Black ■
- .23** Satin aluminium ■

**/WW** 3000K LED 24V 30W 2880lm

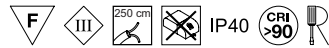

Deckenrosetten mit Treibern sind separat zu bestellen



1 Verdrängungskomponente enthalten

## AUSFÜHRUNGEN CODE



**.01** Weiß      **.02** Schwarz      **.23** Aluminium satiniert



Deckenrosetten mit Konverter für Aufhängesysteme siehe Seite 218

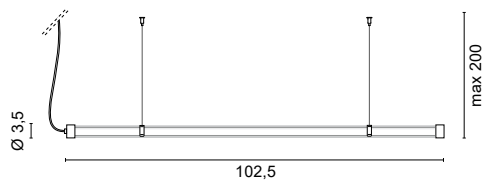

**1666.**\_\_/\_/\_\_\_ 0,75 Kg

- .01** White ■
- .02** Black ■
- .23** Satin aluminium ■

**/WW** 3000K LED 24V 20W 1920lm



Deckenrosetten mit Treibern sind separat zu bestellen

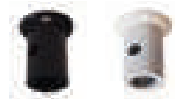

1 Verdrängungskomponente enthalten

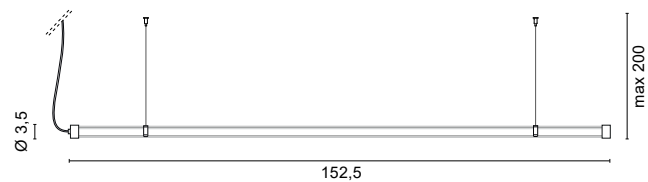

**1667.**\_\_/\_/\_\_\_ 1,10 Kg

- .01** White ■
- .02** Black ■
- .23** Satin aluminium ■

**/WW** 3000K LED 24V 30W 2880lm



Deckenrosetten mit Treibern sind separat zu bestellen



1 Verdrängungskomponente enthalten

## AUSFÜHRUNGEN CODE

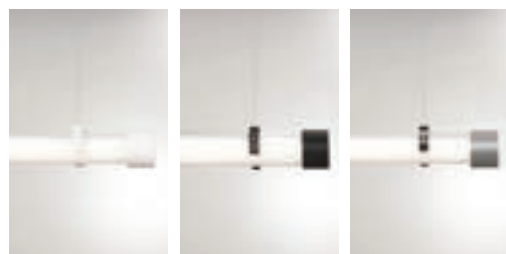

**.01** Weiß

**.02** Schwarz

**.23** Aluminium satiniert



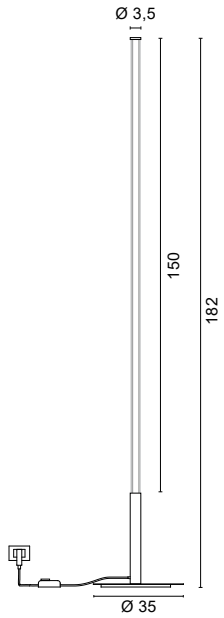

**3546.**\_\_/\_/\_\_\_ 5,00 Kg

- .01 White
- .02 Black

**/WW** 3000K LED 24V 30W 2880lm



Mit DIMMER am schwarzen Kabel

## AUSFÜHRUNGEN CODE



**.01** Weiß

**.02** Schwarz





# DECKENROSETTEN SYSTEM 24V

TRE&SESSANTA system

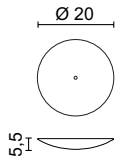
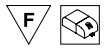

Deckenrosette mit **60W** Konverter 50/60Hz 220-230V

**0990/60.**\_\_/\_/\_\_\_ 0,70Kg

.01	White	
.02	Black	
.85	Painted silver finishing	
.86	Painted gold finishing	
.87	Painted copper finishing	
.88	Painted bronze finishing	

/P	DIMMER		MAX 60W
/V	DIMMER		MAX 60W
/D	DIMMER		MAX 60W

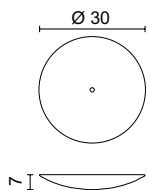

Deckenrosette mit **150W** Konverter 50/60Hz 220-230V

**0990/150.**\_\_/\_/\_\_\_ 1,30Kg

.01	White	
.02	Black	
.85	Painted silver finishing	
.86	Painted gold finishing	
.87	Painted copper finishing	
.88	Painted bronze finishing	

/P	DIMMER		MAX 150W
/V	DIMMER		MAX 150W
/D	DIMMER		MAX 150W



Deckenrosette mit **30W** Konverter 50/60Hz 220-230V

**0990/30.**\_\_/\_/\_\_\_ 0,50Kg

.01	White	
.02	Black	
.23	Satin Aluminium	

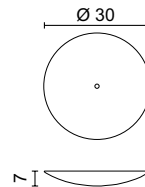

Deckenrosette mit **100W** Konverter 50/60Hz 220-230V

**0990/100.**\_\_/\_/\_\_\_ 1,30Kg

.01	White	
.02	Black	
.85	Painted silver finishing	
.86	Painted gold finishing	
.87	Painted copper finishing	
.88	Painted bronze finishing	

/P	DIMMER		MAX 100W
/V	DIMMER		MAX 100W
/D	DIMMER		MAX 100W

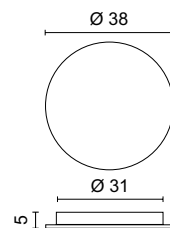

Deckenrosette mit **200W** Konverter 50/60Hz 220-230V

**0990/200.**\_\_/\_/\_\_\_ 2,00 kg

.01	White	
.02	Black	
.85	Painted silver finishing	
.86	Painted gold finishing	
.87	Painted copper finishing	
.88	Painted bronze finishing	

/P	DIMMER		MAX 2x100W
/V	DIMMER		MAX 2x100W
/D	DIMMER		MAX 2x100W

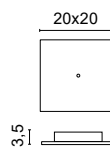

Deckenrosette mit **60W** Konverter 50/60Hz 220-230V

**0993/60.**\_\_/\_/\_\_\_ 0,60Kg

.01	White	
.02	Black	
.23	Satin Aluminium	

/P	DIMMER	
/V	DIMMER	
/D	DIMMER	

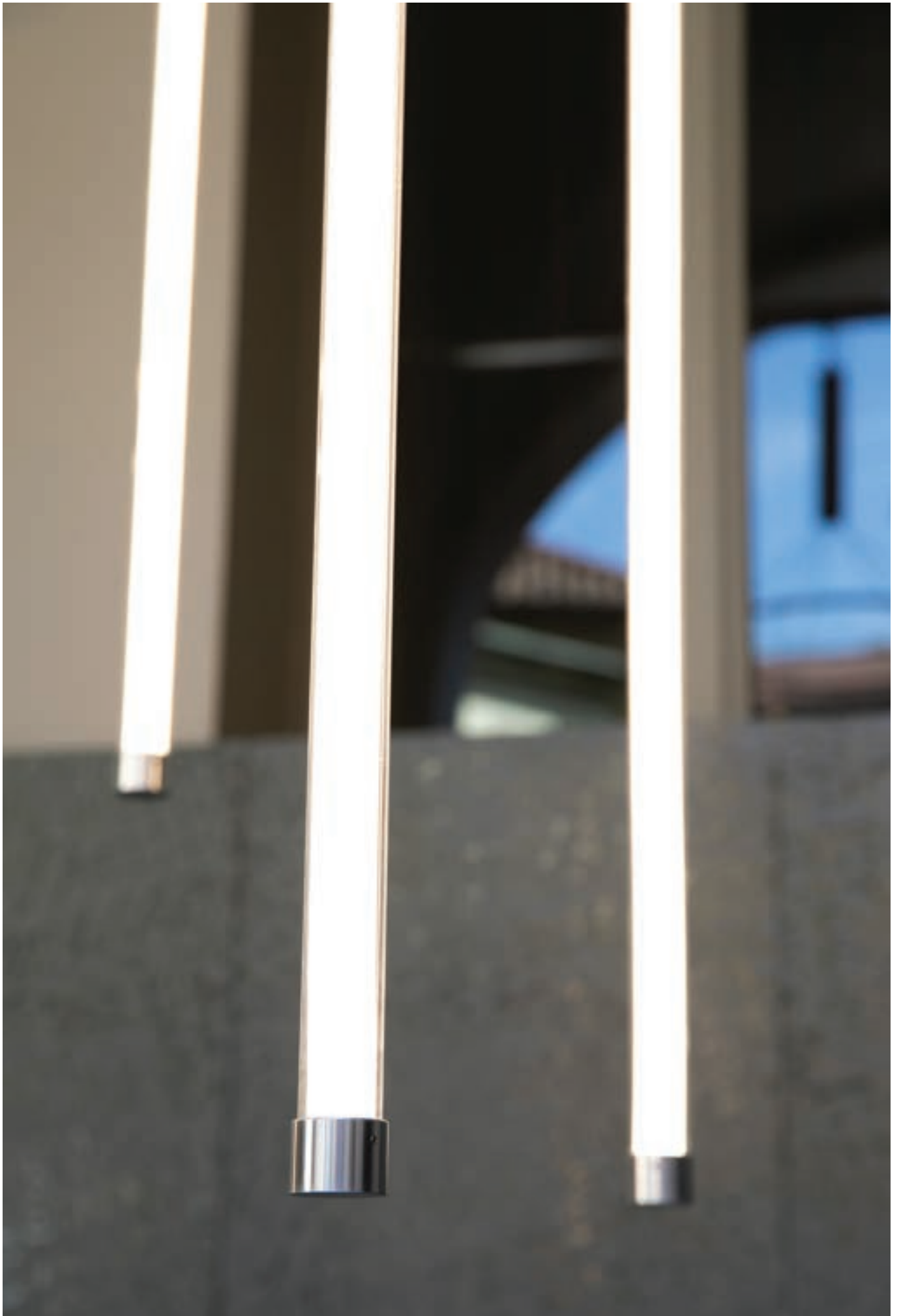





**INDOOR**

# **ALEA**

Design ABS Studio





Die ALEA-Familie besteht aus Wand- und Deckenvarianten. Ihre unauffällige aber gleichzeitig elegante Form ermöglicht es diesen Leuchten sich sowohl in klassischen Umgebungen als auch in modernen Wohn- und Geschäftsräume zu integrieren.

Erhältlich in Versionen mit COB-LED-Quelle und eingebautem Netzteil oder mit traditionellem Leuchtmittel (GU10 - G9). Eine Reihe von optionalen Schirmen ermöglicht es, verschiedene Lichteffekte zu erzielen.



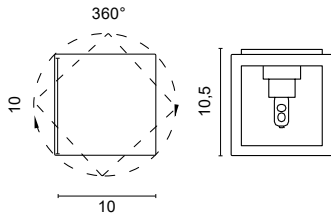

**4281. \_\_** 0,50 Kg

- .01** White ■
- .02** Black ■
- .35** Painted Sand finishing ■

G9 3,5W LED

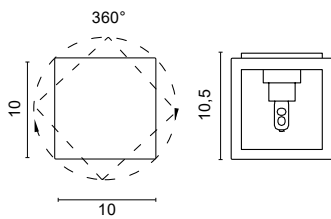

**4282. \_\_** 0,50 Kg

- .57** White glass ■

G9 3,5W LED

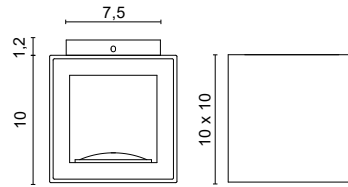

**4561. \_\_ / \_\_** 0,70 Kg

- .01** White ■
- .01.11** Out white / In pink ■
- .01.30** Out white / In silver leaf ■
- .02.01** Out black / In white ■
- .02.29** Out black / In gold leaf ■
- .25.01** Out gold satin / In white ■
- .31.01** Out chromed / In white ■
- .35** Painted Sand finishing ■

<b>/W</b>	4000K	LED 6W	1073lm
<b>/WW</b>	3000K	LED 6W	1011lm
<b>/XW</b>	2700K	LED 6W	970lm



## ZUBEHÖR

Schirm für einzelne Seitenleuchte

### 0182

- .01** White ■
- .02** Black ■
- .35** Painted Sand finishing ■

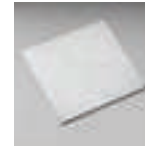

## ZUBEHÖR



Steel Plate  
**0187**

Stahlplatte mit dreieckiger Öffnung  
max 33W ECO.

- .01** White ■
- .02** Black ■
- .35** Painted Sand finishing ■



Steel Plate  
**0189**

Stahlplatte mit zentralem Schlitz  
max 20W ECO.

- .01** White ■
- .02** Black ■
- .35** Painted Sand finishing ■

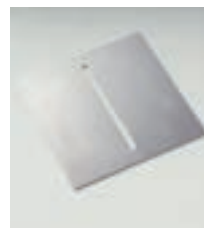

Steel Plate  
**0205**

Stahlrahmen mit Plexiglas  
max 20W ECO.

- .01** White ■
- .02** Black ■
- .35** Painted Sand finishing ■

## AUSFÜHRUNGEN CODE

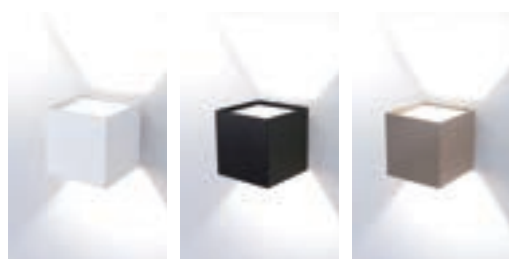

**.01** Weiß **.02** Schwarz **.35** Sand lackiert





## AUSFÜHRUNGEN CODE



**.01.11**  
Außen Weiß  
Innen Rosa



**.01.30**  
Außen Weiß  
Innen Blattsilber



**.02.01**  
Außen Schwarz  
Innen Weiß



**.02.29**  
Außen Schwarz  
Innen Blattgold



**.25.01**  
Außen Gold satiniert  
Innen Weiß



**.31.01**  
Außen Verchromt  
Innen Weiß

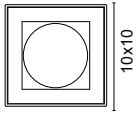

**5176.**\_\_ 0,50 Kg

- .01** White ■
- .02** Black ■
- .35** Painted Sand finishing ■

GU10 LED 7W

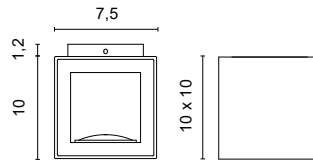

**5561.**\_\_/\_ 0,70 Kg

- .01** White ■
- .02** Black ■

<b>/W</b>	4000K	LED 6W	1073lm
<b>/WW</b>	3000K	LED 6W	1011lm
<b>/XW</b>	2700K	LED 6W	970lm

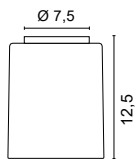
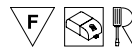

**5185.**\_\_ 0,80 Kg

- .57** White glass ■

G9 LED 3,5W



## ZUBEHÖR

Rahmen

**0205**

Rahmen mit sandgestrahltem Glas - IP40  
Nur für 5176 Lampe H. max 55 mm.

- .01** White ■
- .02** Black ■
- .35** Painted Sand finishing ■

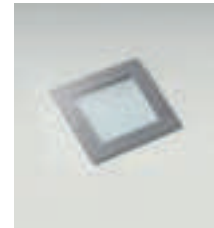

## AUSFÜHRUNGEN CODE

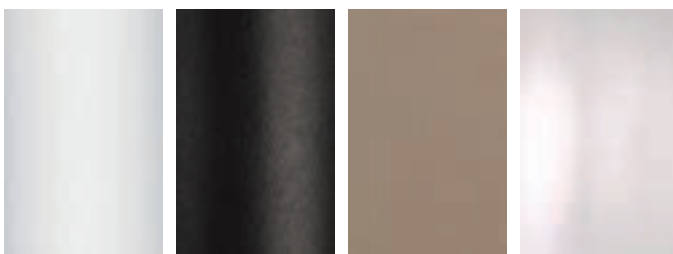

**.01** Weiß **.02** Schwarz **.35** Sand lackiert **.57** Weißes Glas







**INDOOR**

**CI**

Design S. Cornellisen





Wandleuchten in verschiedenen Größen für Streiflicht. Durch die Anordnung der Stromkreise entlang der Gesamtlänge des Profils erhalten wir eine äußerst leistungsstarke Lampe.

Durch das minimalistische Design eignet sich diese Lampe für jede Art von Umgebung, sowohl für klassische als auch für moderne Innenräume.

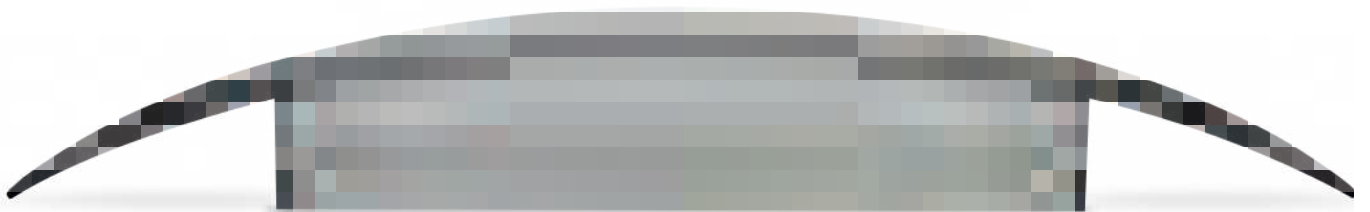

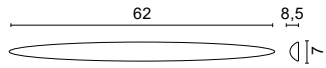

**4574.**\_\_/\_/\_\_\_ 1,70 Kg

- .01 White
- .02 Black
- .23 Satin Aluminium

/W	4000K	LED 12,5W	1930lm
/WW	3000K	LED 12,5W	1830lm

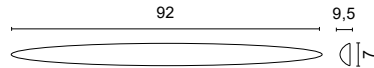

**4575.**\_\_/\_/\_\_\_ 2,00 Kg

- .01 White
- .02 Black
- .23 Satin Aluminium

/W	4000K	LED 25W	3860lm
/WW	3000K	LED 25W	3680lm

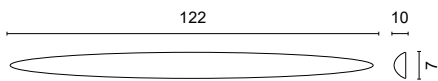

**4576.**\_\_/\_/\_\_\_ 3,00 Kg

- .01 White
- .02 Black
- .23 Satin Aluminium

/W	4000K	LED 37,5W	5790lm
/WW	3000K	LED 37,5W	5520lm

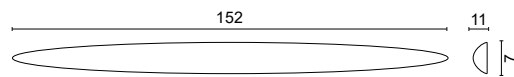

**4577.**\_\_/\_/\_\_\_ 3,90 Kg

- .01 White
- .02 Black
- .23 Satin Aluminium

/W	4000K	LED 50W	7720lm
/WW	3000K	LED 50W	7360lm



AUSFÜHRUNGEN CODE

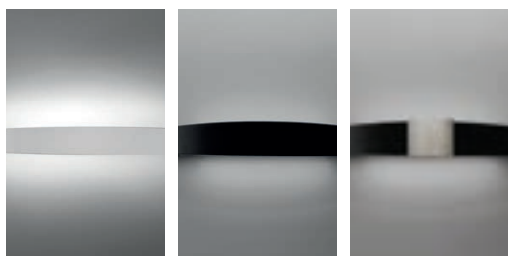

.01 Weiß      .02 Schwarz      .23 Aluminium satiniert





*Project Studio Keyart Milano*



INDOOR

# FUSÒ

Design & Studio







Wandleuchte mit diffusem Licht aus weißem satiniertem mundgeblasenem Glas mit verchromten Details und Lampenfassung mit E27 Fassung. Erhältlich in zwei Größen.

Die elegante Linie verleiht ihr ein Aussehen, das sich gut an jede Umgebung anpasst, von klassischen bis zu modernen Innenräumen und jedem Kontext, von Wohn- bis zu Touristenunterkünften.

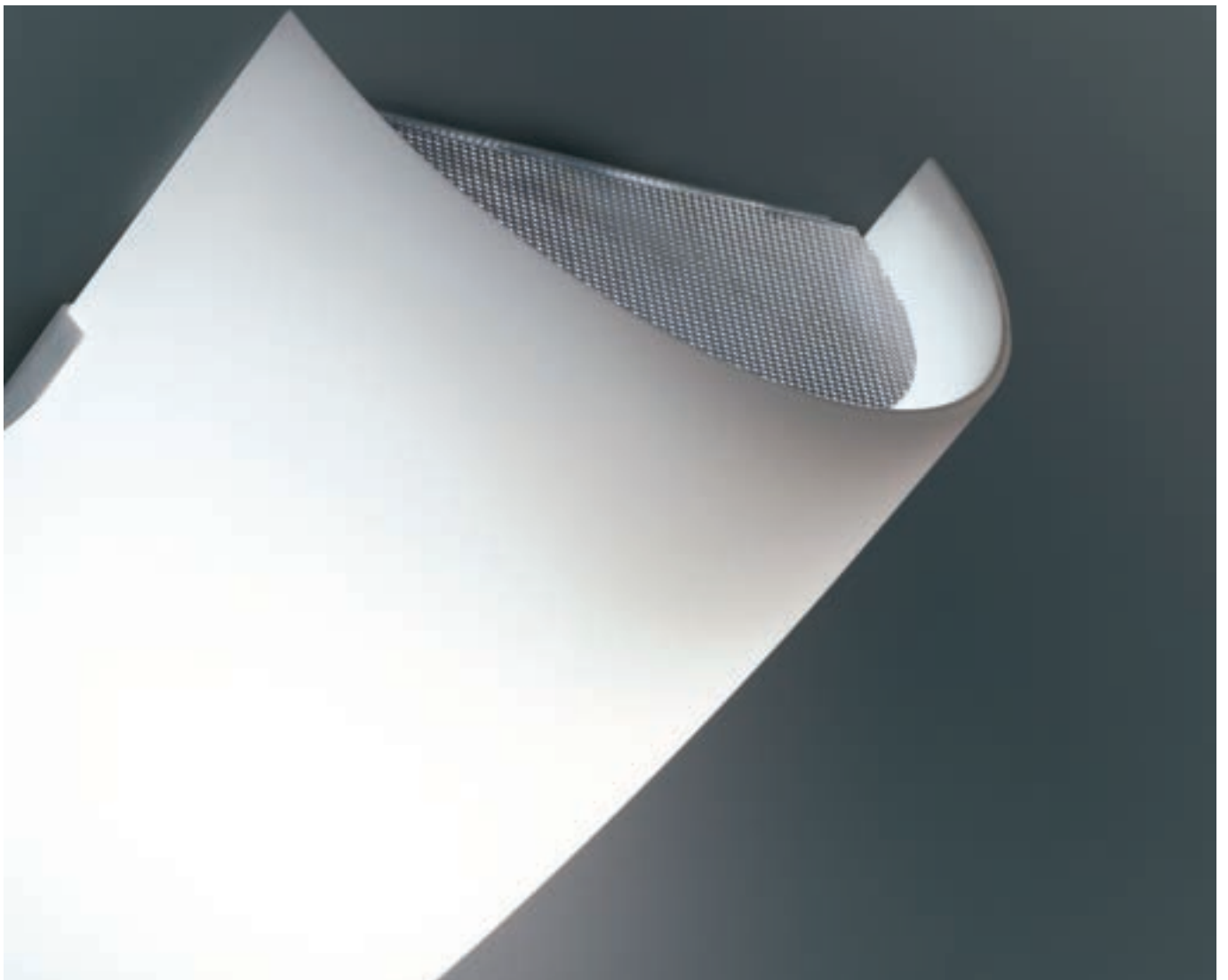

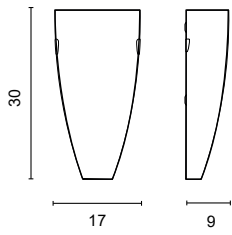

**4021.**\_\_ 0,90 Kg

**.57** White glass

E27 12W LED

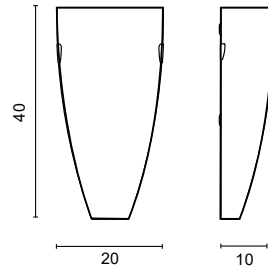

**4023.**\_\_ 1,50 Kg

**.57** White glass

E27 15W LED



## ZUBEHÖR



Schutz  
**0009/P**

Schutzgitter



Schutz  
**0009/G**

Schutzgitter

## AUSFÜHRUNGEN CODE



**.57** Weißes Glas









**INDOOR**

# AURORA

Design LUX Studio



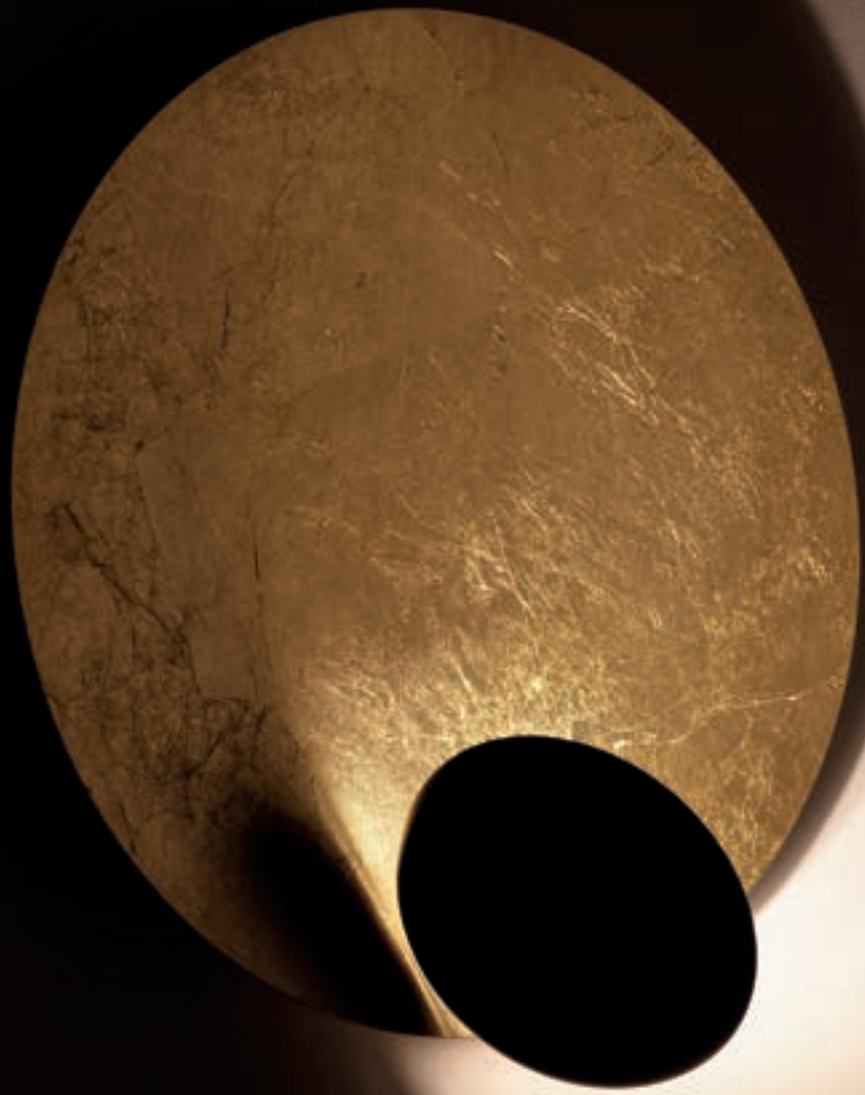

Die Aurora-Familie bietet Wand- und Deckenleuchten mit indirektem Licht, Aluminium- und Metallstrukturen.

Die Lichtquelle mit COB-LED-Technologie und separatem Konverter garantiert eine hohe Lichtausbeute von mehr als 2300lm bei 3000K mit einem Verbrauch von nur 13,8W.

Die Möglichkeit, den Lichtaustritt zu lenken und zu kontrollieren, erlaubt es, die Qualitäten der LED-Quelle optimal zu nutzen und gleichzeitig störende Blendungserscheinungen zu vermeiden.



# AURORA

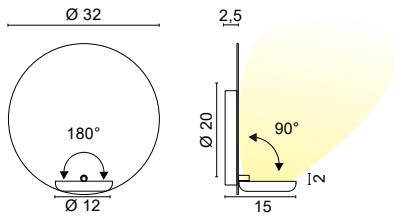

**4627.**\_\_/\_/\_\_\_ 1,50 Kg

<b>.01</b>	White	■
<b>.02.29</b>	Black, Gold leaf	■
<b>.25.01</b>	Golden satin, White	■
<b>.32.01</b>	Nickel mat, White	■

<b>/W</b>	4000K	LED 12,6W	2390lm
<b>/WW</b>	3000K	LED 12,6W	2253lm
<b>/XW</b>	2700K	LED 12,6W	2156lm

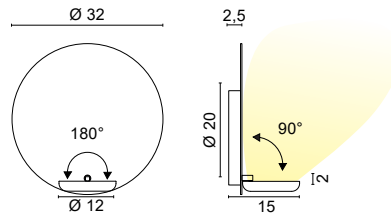
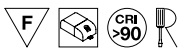

**4628.**\_\_/\_/\_\_\_ 1,50 Kg

<b>.01</b>	White	■
<b>.02.29</b>	Black, Gold leaf	■
<b>.25.01</b>	Golden satin, White	■
<b>.32.01</b>	Nickel mat, White	■

<b>/W</b>	4000K	LED 12,6W	2390lm
<b>/WW</b>	3000K	LED 12,6W	2253lm
<b>/XW</b>	2700K	LED 12,6W	2156lm



Dimmbar PUSH - 1...10V - PUSH - 1...10 dim.

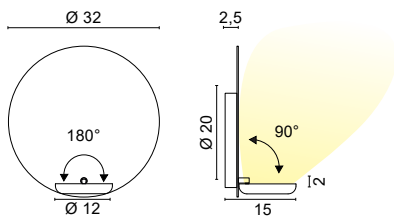

**4629.**\_\_/\_/\_\_\_ 1,50 Kg

<b>.01</b>	White	■
<b>.02.29</b>	Black, Gold leaf	■
<b>.25.01</b>	Golden satin, White	■
<b>.32.01</b>	Nickel mat, White	■

<b>/W</b>	4000K	LED 12,6W	2390lm
<b>/WW</b>	3000K	LED 12,6W	2253lm
<b>/XW</b>	2700K	LED 12,6W	2156lm



Dimmbares DALI - DALI Dimmen

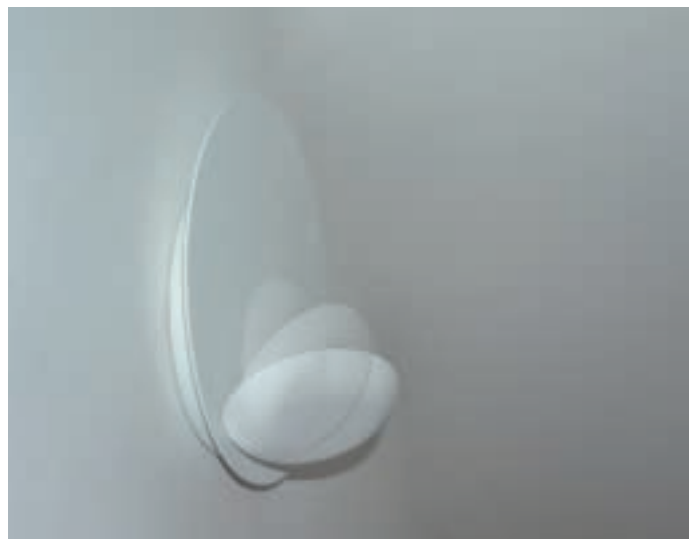

## AUSFÜHRUNGEN CODE

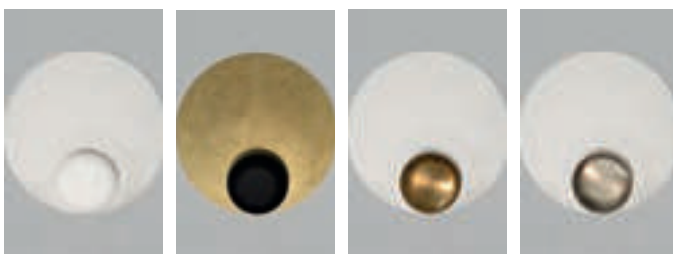

**.01** Weiß      **.02.29** Schwarz Blattgold      **.25.01** Gold Satin Weiß      **.32.01** Nickel matt Weiß



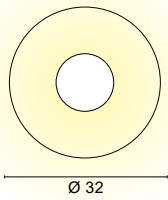
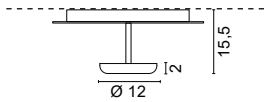

**5675**... / ... 1,50 Kg

**.01** White

<b>/W</b>	4000K	LED 12,6W	2390lm
<b>/WW</b>	3000K	LED 12,6W	2253lm
<b>/XW</b>	2700K	LED 12,6W	2156lm

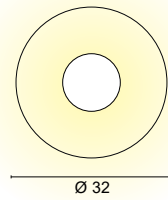
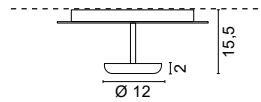
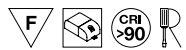

**5676**... / ... 1,50 Kg

**.01** White

<b>/W</b>	4000K	LED 12,6W	2390lm
<b>/WW</b>	3000K	LED 12,6W	2253lm
<b>/XW</b>	2700K	LED 12,6W	2156lm



Dimmbar PUSH - 1...10V - PUSH - 1...10 dim.

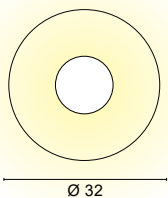
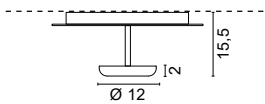

**5677**... / ... 1,50 Kg

**.01** White

<b>/W</b>	4000K	LED 12,6W	2390lm
<b>/WW</b>	3000K	LED 12,6W	2253lm
<b>/XW</b>	2700K	LED 12,6W	2156lm



Dimmbares DALI - DALI-Dimmen

## AUSFÜHRUNGEN CODE



**.01** Weiß

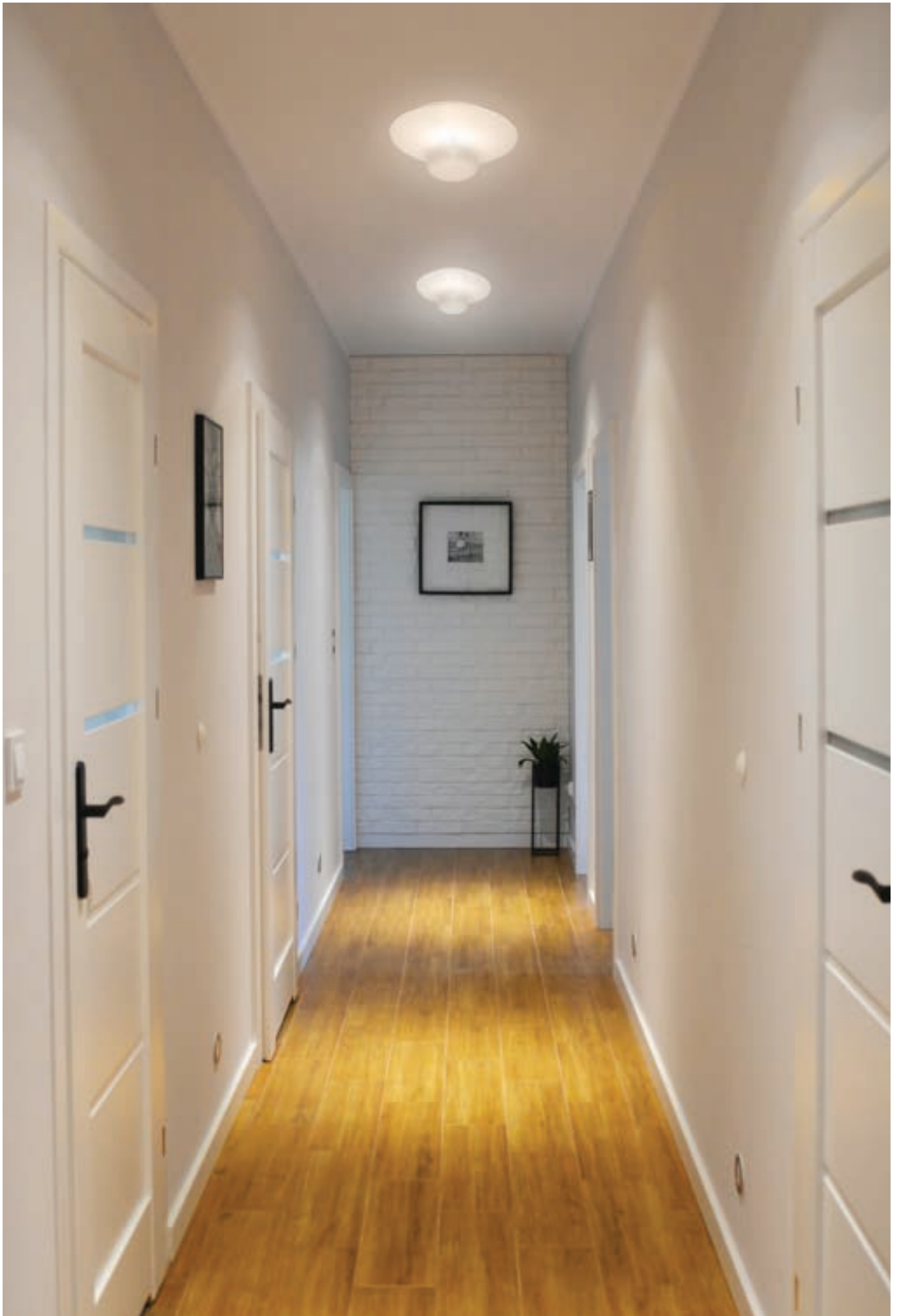





INDOOR

# VIRGOLA

Design LUX Studio





Hänge und Stehleuchten mit diffusem Licht mit Aluminiumgehäuse und opalem Polycarbonat-Diffusor, der sich durch einen großen, aber schlanken Bogen auszeichnet.

Der besondere Lichtstrom, der auf die Innenseite des Bogens gerichtet ist, garantiert einen guten Sehkomfort und trägt dazu bei, die Leichtigkeit der Struktur zu verstärken.

Bei der Pendelversion muss die Rosette mit Netzteil separat bestellt werden.



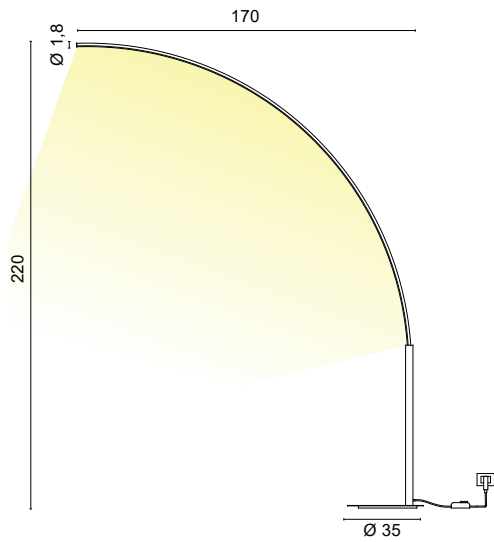

**3535.**\_\_/\_

7,00 Kg

.01	White	
.02	Black	

/W	4000K	LED 33W	4048lm
/WW	3000K	LED 33W	3630lm
/XW	2700K	LED 33W	3432lm

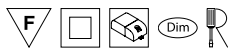

Mit DIMMER am schwarzen Kabel

## AUSFÜHRUNGEN CODE

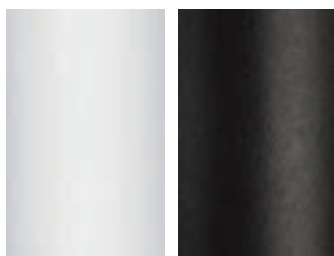

**.01** Weiß

**.02** Schwarz



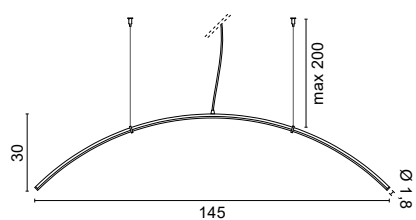

**1584.**\_\_/\_/\_\_\_ 0,45 Kg

- .01** White
- .02** Black

<b>/W</b>	4000K	LED 24V 27W	3390lm
<b>/WW</b>	3000K	LED 24V 27W	3030lm
<b>/XW</b>	2700K	LED 24V 27W	2835lm



Deckenrosetten mit Treibern sind separat zu bestellen

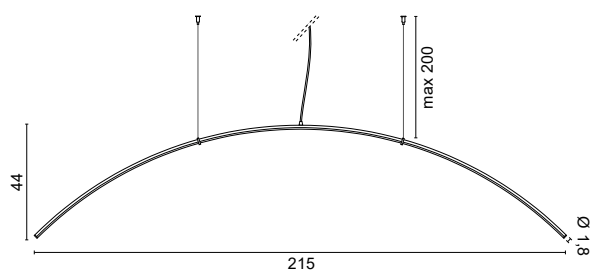

**1585.**\_\_/\_/\_\_\_ 0,70 Kg

- .01** White
- .02** Black

<b>/W</b>	4000K	LED 24V 41,4W	5198lm
<b>/WW</b>	3000K	LED 24V 41,4W	4646lm
<b>/XW</b>	2700K	LED 24V 41,4W	4347lm



Deckenrosetten mit Treibern sind separat zu bestellen

## AUSFÜHRUNGEN CODE

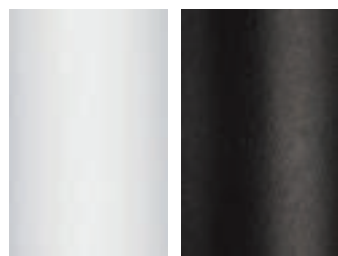

**.01** Weiß

**.02** Schwarz



Deckenrosetten mit Konverter für Aufhängesysteme siehe Seite 256

# DECKENROSETTEN SYSTEM 24V

VIRGOLA

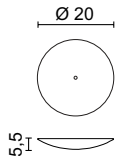

Deckenrosette mit **60W** Konverter 50/60Hz 220-230V

**0990/60.**\_\_/\_/\_\_\_ 0,70Kg

- .01 White ■
- .02 Black ■
- .85 Painted silver finishing ■
- .86 Painted gold finishing ■
- .87 Painted copper finishing ■
- .88 Painted bronze finishing ■

/P	DIMMER		MAX 60W
/V	DIMMER		MAX 60W
/D	DIMMER		MAX 60W

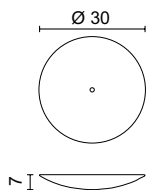

Deckenrosette mit **150W** Konverter 50/60Hz 220-230V

**0990/150.**\_\_/\_/\_\_\_ 1,30Kg

- .01 White ■
- .02 Black ■
- .85 Painted silver finishing ■
- .86 Painted gold finishing ■
- .87 Painted copper finishing ■
- .88 Painted bronze finishing ■

/P	DIMMER		MAX 150W
/V	DIMMER		MAX 150W
/D	DIMMER		MAX 150W

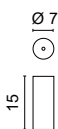

Deckenrosette mit **30W** Konverter 50/60Hz 220-230V

**0990/30.**\_\_/\_/\_\_\_ 0,50Kg

- .01 White ■
- .02 Black ■
- .23 Satin Aluminium ■

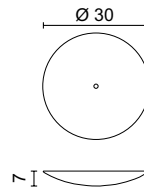

Deckenrosette mit **100W** Konverter 50/60Hz 220-230V

**0990/100.**\_\_/\_/\_\_\_ 1,30Kg

- .01 White ■
- .02 Black ■
- .85 Painted silver finishing ■
- .86 Painted gold finishing ■
- .87 Painted copper finishing ■
- .88 Painted bronze finishing ■

/P	DIMMER		MAX 100W
/V	DIMMER		MAX 100W
/D	DIMMER		MAX 100W

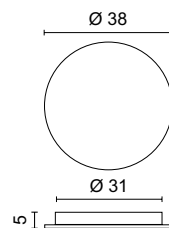

Deckenrosette mit **200W** Konverter 50/60Hz 220-230V

**0990/200.**\_\_/\_/\_\_\_ 2,00 kg

- .01 White ■
- .02 Black ■
- .85 Painted silver finishing ■
- .86 Painted gold finishing ■
- .87 Painted copper finishing ■
- .88 Painted bronze finishing ■

/P	DIMMER		MAX 2x100W
/V	DIMMER		MAX 2x100W
/D	DIMMER		MAX 2x100W

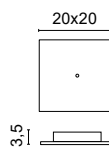

Deckenrosette mit **60W** Konverter 50/60Hz 220-230V

**0993/60.**\_\_/\_/\_\_\_ 0,60Kg

- .01 White ■
- .02 Black ■
- .23 Satin Aluminium ■

/P	DIMMER	
/V	DIMMER	
/D	DIMMER	









INDOOR

# SPIRITS

Design S. Cornelissen





## SPIRITS



Pendelleuchte mit indirektem Licht.

Ein elegantes Design, das klassische Formen aufgreift, neue Funktionen vorschlägt und sich gut in jede öffentliche oder private Umgebung und in jeden Stil, klassisch oder modern, einfügt.

Durch die ungewöhnliche Anordnung der LEDs im unteren Teil des Gerätes entstehen unerwartete Reflexionen und Lichtprojektionen.

Die Deckenrosetten mit Netzteil sind je nach gewählter Zusammenstellung separat zu bestellen.



# SPIRITS

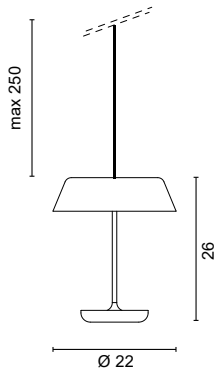

**1535.**\_\_/\_ \_\_ 1,00 Kg

- .01** White ■
- .01.30** Out white / In silver leaf ■
- .02.29** Out black / In gold leaf ■

**/WW** 3000K LED 51V 250mA 12,6W 2253lm



Nur serielle Verbindung

## ZUBEHÖR

1 Verbindungselement Ø 1,7 cm H 2,2cm

- 0605**
- .01** White ■
- .02** Black ■

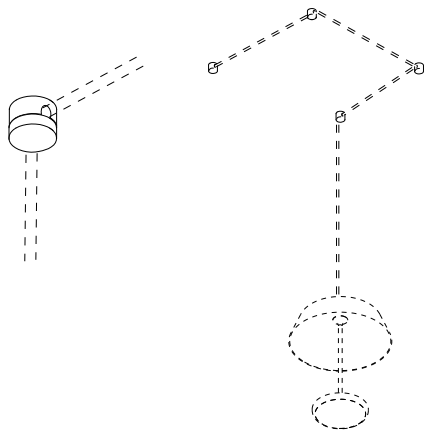

## AUSFÜHRUNGEN CODE



**.01** Weiß



**.01.30** Außen Weiß  
Innen Blattsilber



**.02.29** Außen Schwarz  
Innen Blattgold



Deckenrosetten mit Konverter für Aufhängesysteme siehe Seite 264

# DECKENROSETTEN FÜR SPIRITS KOMPOSITIONEN

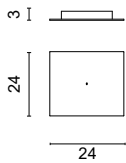

Deckenrosette mit Konverter - 1 Spirits  
**IN** 50/60Hz 220-240V

**0951** 1,00 Kg

- .01 White ■
- .02 Black ■

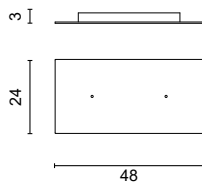

Deckenrosette mit Konverter - 2 Spirits  
**IN** 50/60Hz 220-240V

**0952** 2,00 Kg

- .01 White ■
- .02 Black ■

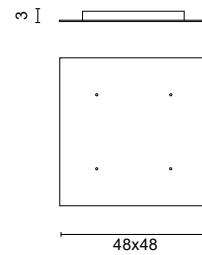

Deckenrosette mit Konverter - 4 Spirits  
**IN** 50/60Hz 220-240V

**0953** 3,80 Kg

- .01 White ■
- .02 Black ■

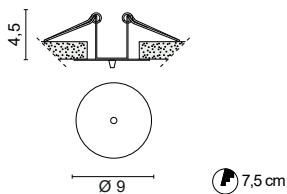

Deckenrosette aus Gipskarton mit Kon-  
 verter 1 Spirits  
**IN** 50/60Hz 220-240V

**0954** 0,20 Kg

- .01 White ■
- .02 Black ■

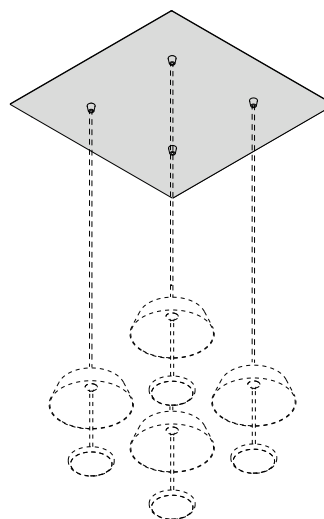
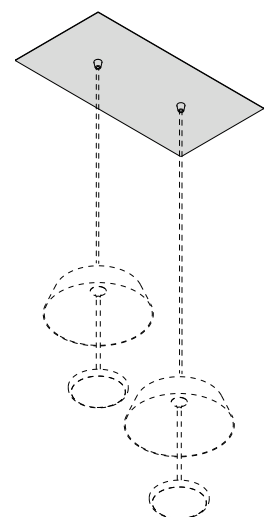
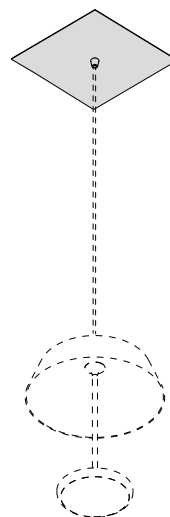







A close-up photograph of a bed. The headboard is upholstered in a textured grey fabric. The bed is made with white linens, including a fitted sheet and several pillows. The lighting is soft and even, highlighting the textures of the fabric.

**INDOOR**

# LEGGO

Design Mati





Verstellbare Wandleuchte aus Aluminium mit Metallstruktur.

Trotz seiner geringen Größe sind Schalter und Netzteil in das Gehäuse des Produkts integriert.

Der im Gehäuse des Projektors angebrachte Magnet ermöglicht eine einfache Ausrichtung des Lichts in alle Richtungen.



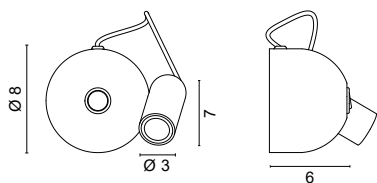

4670. \_\_ / \_\_

0,35 Kg

.01 White



.02 Black



/W 4000K LED 2,4W 477lm

/WW 3000K LED 2,4W 463lm

/XW 3000K LED 2,4W 453lm

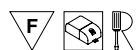

Komplett mit ON-OFF Taste



## AUSFÜHRUNGEN CODE

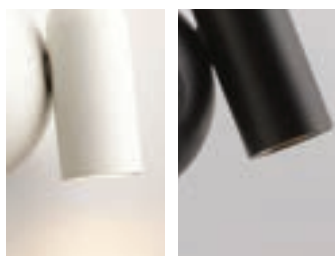

.01 Weiß

.02 Schwarz









INDOOR

# KALLA

Design ABS Studio





# KALLA



Flexible und verstellbare Wandleuchte für direktes Licht mit Aluminium- und ABS-Struktur. Die Power-LED und der Konverter sind integriert. Erhältlich in verschiedenen Arten der Befestigung mit oder ohne Schalter.

Die geringe Größe, die einfache, aber fesselnde Linie und die Varianten in verschiedenen Farben machen KALLA zu einer äußerst vielseitigen Leuchte; ideal als Leselampe kann sie optimal als Akzentlicht verwendet werden, um Objekte oder Einrichtungsgegenstände hervorzuheben.



# KALLA / KALLA DUE

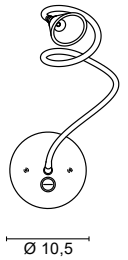
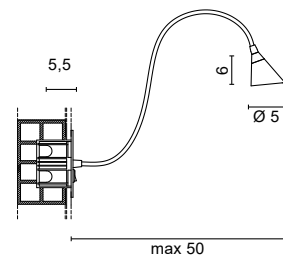
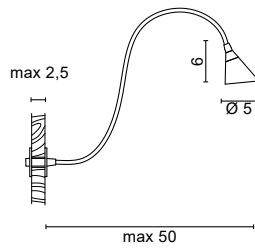
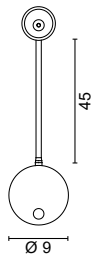
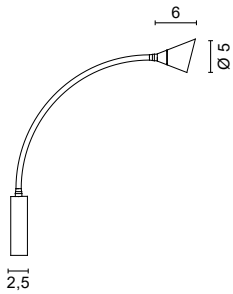

**4501.**\_\_/\_/\_\_\_

0,30 Kg

.01	White	
.02	Black	
.06	Green	
.09	Orange	
.10	Light blue	
.11	Pink	

/W	4000K	LED 1W	on request
/WW	3000K	LED 1W	146lm
/XW	2700K	LED 1W	on request



**KALLA**  
Wandmodell mit ON - OFF Schalter

**4540.**\_\_/\_/\_\_\_

0,30 Kg

.01	White	
.02	Black	
.06	Green	
.09	Orange	
.10	Light blue	
.11	Pink	

/W	4000K	LED 1W	on request
/WW	3000K	LED 1W	146lm
/XW	2700K	LED 1W	on request

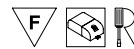

**KALLA DUE**  
Modell für die Montage auf einer Platte

**4541.**\_\_/\_/\_\_\_

0,40 Kg

.01	White	
.02	Black	
.06	Green	
.09	Orange	
.10	Light blue	
.11	Pink	

/W	4000K	LED 1W	on request
/WW	3000K	LED 1W	146lm
/XW	2700K	LED 1W	on request



**KALLA DUE**  
Modell mit ON - OFF Schalter für Wandmontage

## AUSFÜHRUNGEN CODE



**.01** Weiß    **.02** Schwarz    **.06** Grün    **.09** Orange    **.10** Hellblau    **.11** Rosa



SomVita Suites  
Ph. Hannes Niederkofler

## KALLA / KALLA DUE









INDOOR

# RACCORDI DI LUCE JOY

Design officinadiarchitettura&design





Kollektion von IP65 Wand-, Deckenleuchten - geeignet sowohl für den Innen- und Außenbereich mit Materialien aus Aluminium mit verstärkter Eloxierung, als auch in der Ausführung aus satiniertem Edelstahl AISI 316L.

Das System ist eine neue und andere Art, Licht zu interpretieren: Ausgehend von einem einzigen Stromanschluss, ermöglicht die Modularität der verschiedenen Elemente die Schaffung von mehreren Konfigurationen, die das Licht dorthin bringen, wo es benötigt wird.



# RACCORDI DI LUCE - JOY

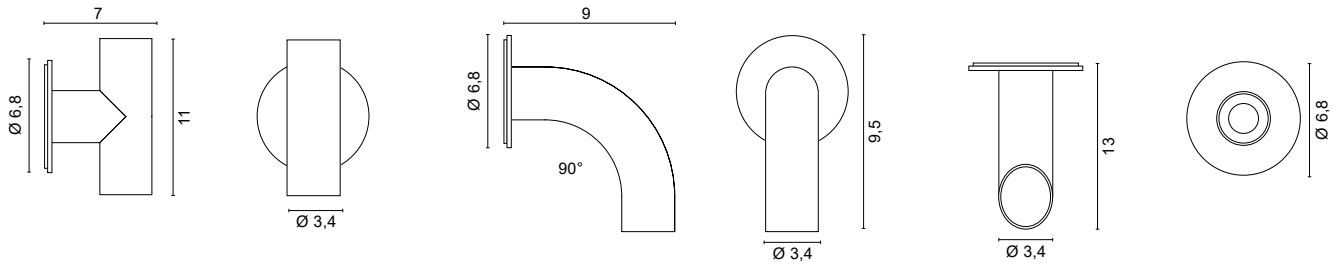

**4672.**\_\_\_/\_\_\_ 0,31 Kg

- .01** White ■
- .02** Black ■
- .33** Stainless Steel AISI 316L ■
- .34** Painted corten finishing ■

<b>/W</b>	4000K	LED 3W	500mA	442lm
<b>/WW</b>	3000K	LED 3W	500mA	420lm
<b>/XW</b>	2700K	LED 3W	500mA	398lm



**4673.**\_\_\_/\_\_\_ 0,25 Kg

- .01** White ■
- .02** Black ■
- .33** Stainless Steel AISI 316L ■
- .34** Painted corten finishing ■

<b>/W</b>	4000K	LED 1,5W	500mA	221lm
<b>/WW</b>	3000K	LED 1,5W	500mA	210lm
<b>/XW</b>	2700K	LED 1,5W	500mA	199lm



**5690.**\_\_\_/\_\_\_ 0,25 Kg

- .01** White ■
- .02** Black ■
- .33** Stainless Steel AISI 316L ■
- .34** Painted corten finishing ■

<b>/W</b>	4000K	LED 1,5W	500mA	221lm
<b>/WW</b>	3000K	LED 1,5W	500mA	210lm
<b>/XW</b>	2700K	LED 1,5W	500mA	199lm



## Konverter ON/OFF

Cod. LED	<b>0143/IP</b>	<b>0127</b>
	500mA	500mA
<b>4672</b>	1-3	1-3
<b>4673</b>	1-7	1-6
<b>5690</b>	1-7	1-6

Only serial connection

## AUSFÜHRUNGEN CODE

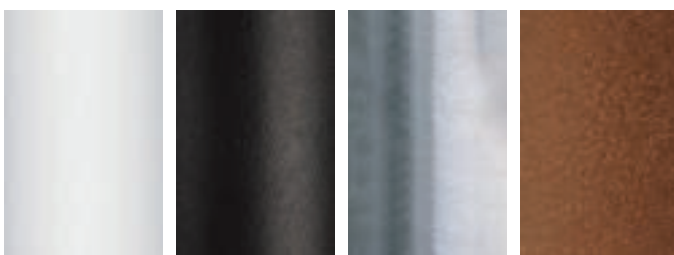

- .01** Weiß
- .02** Schwarz
- .33**  
Edelstahl  
AISI 316L
- .34**  
Lackiert  
Corten

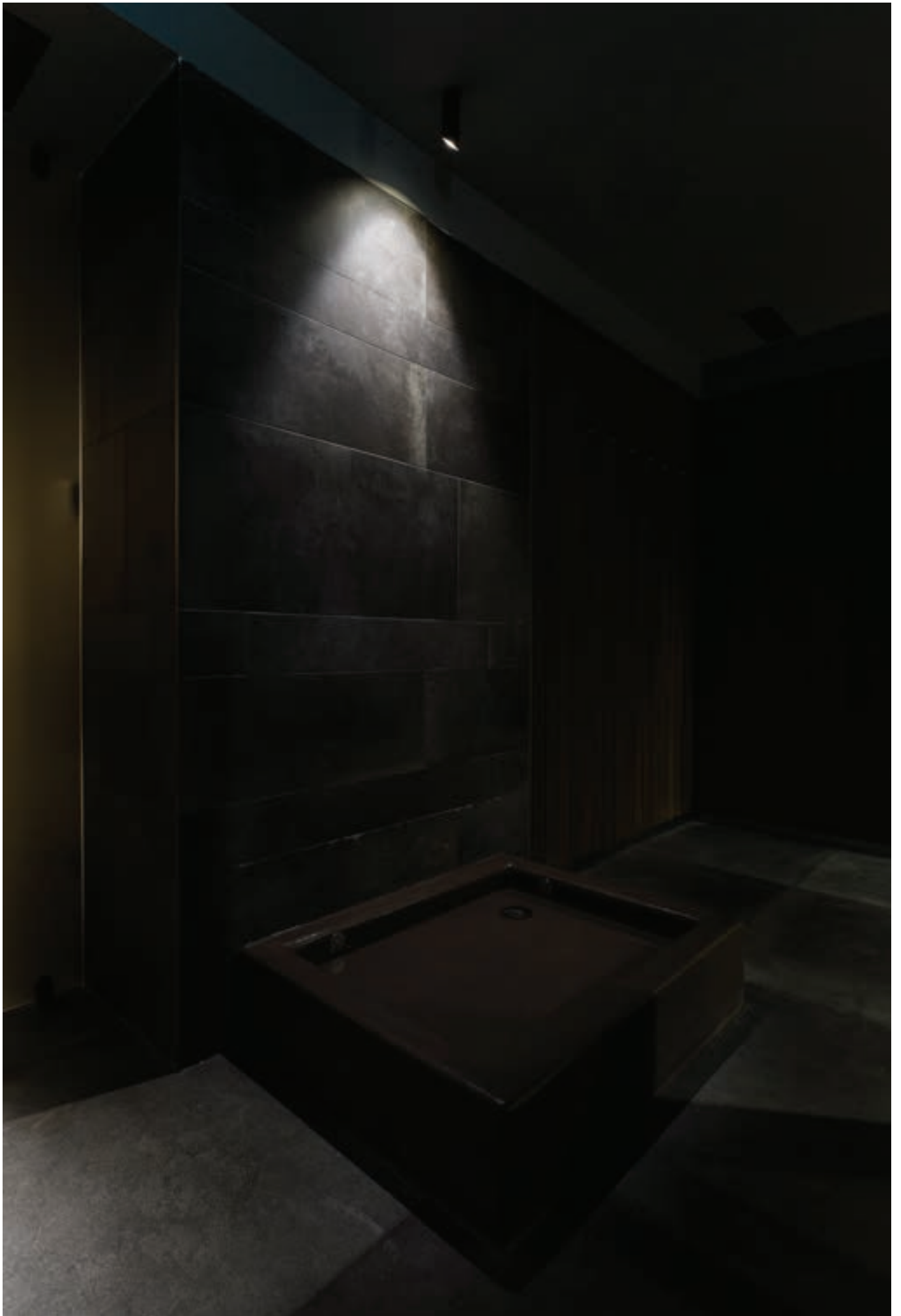



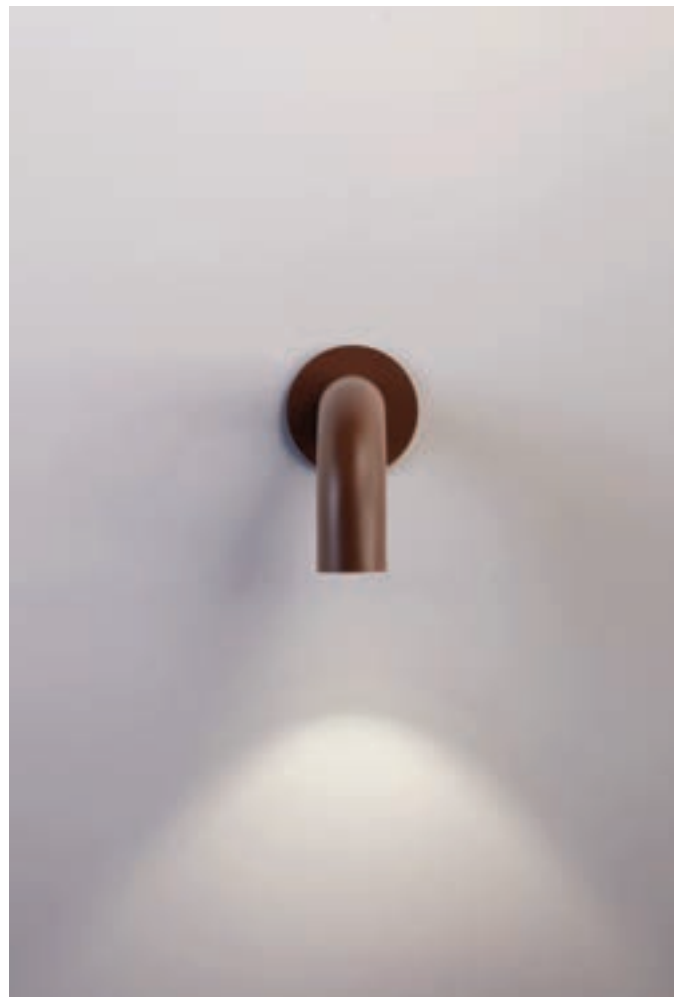
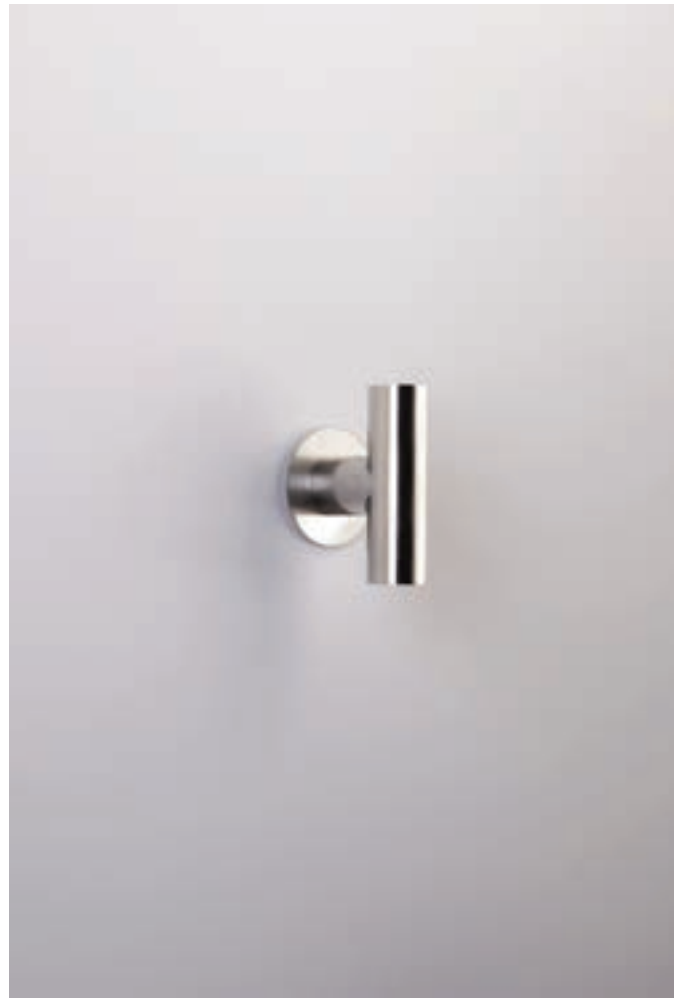
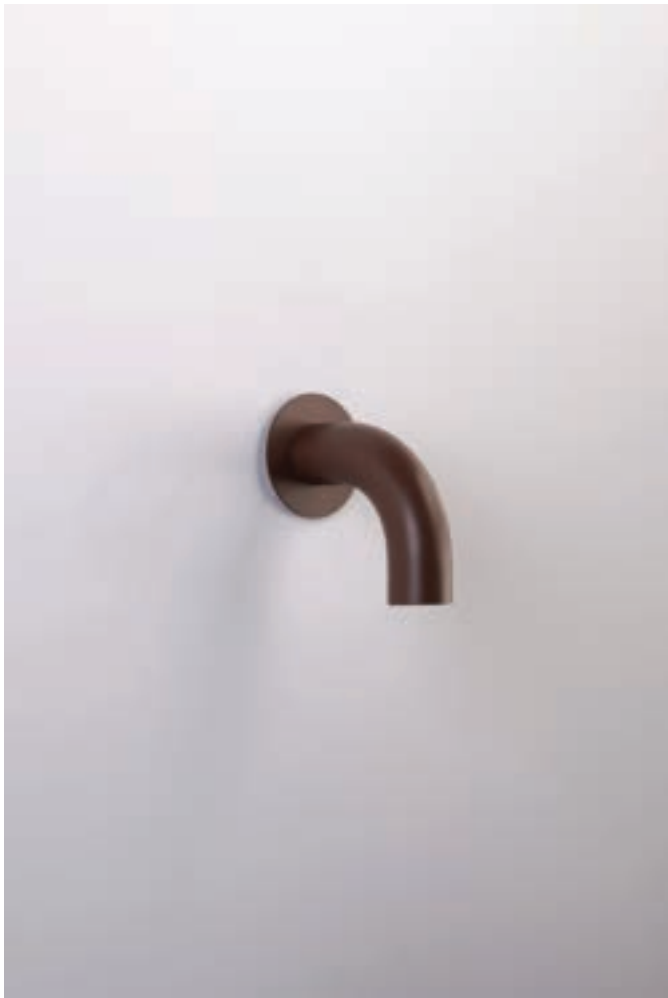





INDOOR

# WANDA

Design U.T. EgoLucé





## WANDA SYSTEM



Verstellbarer IP54-Hängeleuchte mit diffusem Licht aus transparentem, UV-beständigem und koextrudiertem Methacrylat mit Anschlüssen aus Edelstahl.

Auf Anfrage wird Wanda in verschiedenen modularen Längen von 58 cm bis 298 cm und in drei Lichtfarben, 2700K, 3000K und 4000K, mit einem CRI>90 angeboten. Diese einfache, aber effektive Beleuchtung bietet kreative Lösungen für verschiedene Umgebungen, von Büros und Küchen bis hin zu Außenpools und Gärten.



# WANDA SYSTEM

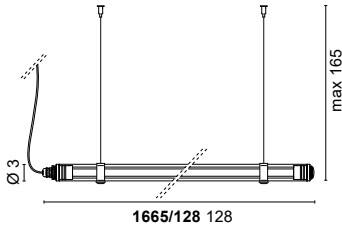

**1665.\_./128/\_** 1,10 Kg

**.33** Matt Steel

<b>/W</b>	4000K	LED 18W CRI>90	2208lm
<b>/WW</b>	3000K	LED 18W CRI>90	1980lm
<b>/XW</b>	2700K	LED 18W CRI>90	1872lm

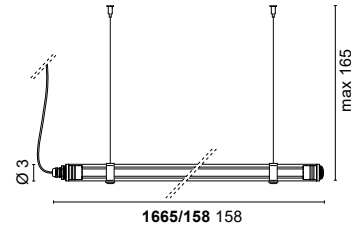

**1665.\_./158/\_** 1,36 Kg

**.33** Matt Steel

<b>/W</b>	4000K	LED 22,5W CRI>90	2760lm
<b>/WW</b>	3000K	LED 22,5W CRI>90	2475lm
<b>/XW</b>	2700K	LED 22,5W CRI>90	2340lm

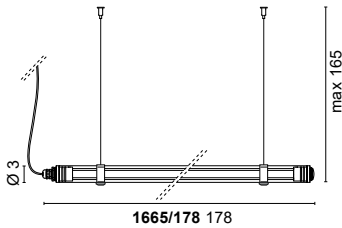

**1665.\_./178/\_** 1,53 Kg

**.33** Matt Steel

<b>/W</b>	4000K	LED 25,5W CRI>90	3128lm
<b>/WW</b>	3000K	LED 25,5W CRI>90	2805lm
<b>/XW</b>	2700K	LED 25,5W CRI>90	2652lm

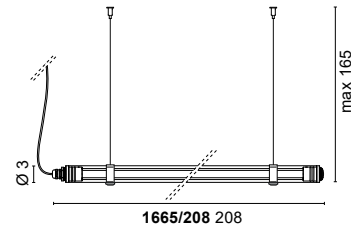

**1665.\_./208/\_** 1,79 Kg

**.33** Matt Steel

<b>/W</b>	4000K	LED 30W CRI>90	3680lm
<b>/WW</b>	3000K	LED 30W CRI>90	3300lm
<b>/XW</b>	2700K	LED 30W CRI>90	3120lm

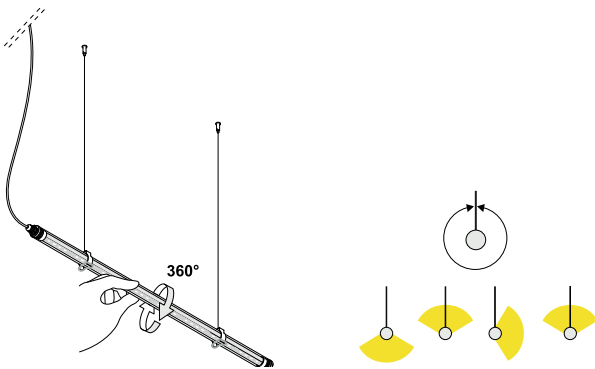

## AUSFÜHRUNGEN CODE



**.33** Matt Stahl



Deckenrosetten mit Konverter für Aufhängesysteme siehe Seite 294

# DECKENROSETTEN SYSTEM 24V

WANDA SYSTEM

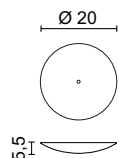

Deckenrosette mit **60W** Konverter 50/60Hz 220-230V

**0990/60.**\_\_/\_/\_\_\_ 0,70Kg

.01	White	
.02	Black	
.85	Painted silver finishing	
.86	Painted gold finishing	
.87	Painted copper finishing	
.88	Painted bronze finishing	

/P	DIMMER		MAX 60W
/V	DIMMER		MAX 60W
/D	DIMMER		MAX 60W

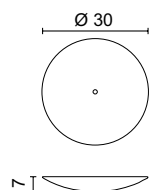

Deckenrosette mit **150W** Konverter 50/60Hz 220-230V

**0990/150.**\_\_/\_/\_\_\_ 1,30Kg

.01	White	
.02	Black	
.85	Painted silver finishing	
.86	Painted gold finishing	
.87	Painted copper finishing	
.88	Painted bronze finishing	

/P	DIMMER		MAX 150W
/V	DIMMER		MAX 150W
/D	DIMMER		MAX 150W

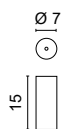

Deckenrosette mit **30W** Konverter 50/60Hz 220-230V

**0990/30.**\_\_/\_/\_\_\_ 0,50Kg

.01	White	
.02	Black	
.23	Satin Aluminium	

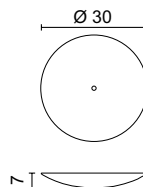

Deckenrosette mit **100W** Konverter 50/60Hz 220-230V

**0990/100.**\_\_/\_/\_\_\_ 1,30Kg

.01	White	
.02	Black	
.85	Painted silver finishing	
.86	Painted gold finishing	
.87	Painted copper finishing	
.88	Painted bronze finishing	

/P	DIMMER		MAX 100W
/V	DIMMER		MAX 100W
/D	DIMMER		MAX 100W

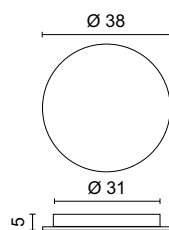

Deckenrosette mit **200W** Konverter 50/60Hz 220-230V

**0990/200.**\_\_/\_/\_\_\_ 2,00 kg

.01	White	
.02	Black	
.85	Painted silver finishing	
.86	Painted gold finishing	
.87	Painted copper finishing	
.88	Painted bronze finishing	

/P	DIMMER		MAX 2x100W
/V	DIMMER		MAX 2x100W
/D	DIMMER		MAX 2x100W

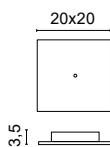

Deckenrosette mit **60W** Konverter 50/60Hz 220-230V

**0993/60.**\_\_/\_/\_\_\_ 0,60Kg

.01	White	
.02	Black	
.23	Satin Aluminium	

/P	DIMMER	
/V	DIMMER	
/D	DIMMER	



## WANDA SYSTEM









## AUSTRIA

### HEADOFFICE WELS

**Office & Showroom**  
Europastraße 45  
4600 Wels, Austria  
+43 7242 698-0  
office@moltoluce.com

### PRODUCTION WEISSKIRCHEN

**Office**  
Gewerbepark 6 + 10  
4616 Weißkirchen, Austria  
+43 7243 60063  
office.weisskirchen@moltoluce.com

### VIENNA

**Office & Showroom**  
Vorarlberger Allee 28  
1230 Vienna, Austria  
+43 1 6160300  
office.wien@moltoluce.com

### GRAZ

**Office**  
Robert-Viertl-Straße 2  
8055 Graz, Austria  
+43 316 672525-0  
office.graz@moltoluce.com

### INNSBRUCK

**Office**  
Orbis Office, Resselstraße 33  
6020 Innsbruck, Austria  
+43 512 345688  
office.innsbruck@moltoluce.com

## GERMANY

### MUNICH

**Office & Showroom**  
Walter-Gropius-Straße 23  
80807 Munich, Germany  
+49 89 4520565-0  
office.muenchen@moltoluce.com

### COLOGNE

**Office & Showroom**  
Eiler Straße 3v  
51107 Cologne, Germany  
+49 221 222882-0  
office.koeln@moltoluce.com

### HAMBURG

**Office & Showroom**  
Wandsbeker Allee 77  
22041 Hamburg, Germany  
+49 40 2847850-1  
office.hamburg@moltoluce.com

## SWITZERLAND

### LENZBURG

**Office**  
Niederlenzerstrasse 25  
5600 Lenzburg, Switzerland  
+41 62 885 70 30  
office.lenzburg@moltoluce.com



MOLTOLUCE.COM



MOLTO LUCE®